



# Operation manual

## PRO bath thermostats and circulation thermostats

P 10, P 20, P 30, RP 3035, RP 2040, RP 2045, RP 1090, RP 2090, RP 10100, RP 240 E, RP 245 E, RP 250 E,  
RP 290 E, P 2 E

with Base operating unit

Manufacturer:

LAUDA DR. R. WOBSEER GMBH & CO. KG

Laudaplatz 1

97922 Lauda-Königshofen

Germany

Telephone: +49 (0)9343 503-0

E-mail: [info@lauda.de](mailto:info@lauda.de)

Internet: <https://www.lauda.de>

Translation of the original operation manual

Q4DA-E.13-020-DE-01 Base, 6, en\_US 08/23/2023 © LAUDA 2021

replaces issue V6R21-14, V5R22-23, V4R15-14-13, V04R07, V4R04, V03REV30-29-28-16, V2RE4, V2R03, V1R54, V01R52, V01R48, V01R35

## Table of contents

<b>1</b>	<b>Safety.....</b>	<b>7</b>
1.1	Safety structure of the devices.....	7
1.2	EMC requirements.....	7
1.3	Software versions.....	8
1.4	Observing additional operating instructions.....	8
1.5	Intended use.....	8
1.6	Foreseeable misuse.....	9
1.7	Prohibition of modifications to the device.....	9
1.8	Materials.....	9
1.9	Fluorinated refrigerant.....	10
1.10	Natural refrigerant.....	10
1.11	Heat transfer liquid requirements.....	10
1.12	Hose requirements.....	11
1.13	Application area.....	11
1.14	Personnel qualification.....	11
1.15	Personal protective equipment.....	11
1.16	Safety fittings on the device.....	11
	1.16.1 Overtemperature protection.....	11
	1.16.2 Low-level protection.....	12
1.17	Warning symbols on the device.....	12
1.18	Warning symbols.....	12
1.19	Structure of warnings.....	13
<b>2</b>	<b>Unpacking.....</b>	<b>14</b>
<b>3</b>	<b>Structure and function.....</b>	<b>16</b>
3.1	Structure.....	16
	3.1.1 Structure of the bath thermostat.....	16
	3.1.2 Structure of the circulation thermostats.....	18
3.2	Operating elements.....	20
	3.2.1 Mains and safety switch.....	20
	3.2.2 Release button and maximum temperature knob.....	20
3.3	Functional elements.....	20
	3.3.1 Hydraulic circuit.....	20
	3.3.2 Refrigerating machine.....	22
	3.3.3 Heat discharge through cooling in a hybrid design.....	23
	3.3.4 Nitrogen overlay.....	23
	3.3.5 Series standard and optional interfaces.....	24
3.4	Rating label.....	26

<b>4</b>	<b>Before starting up.....</b>	<b>29</b>
4.1	Installation.....	29
4.2	Installing interface modules.....	30
4.3	RS 232 interface.....	31
4.3.1	Cable and test of the RS 232 interface.....	31
4.3.2	Protocol RS 232.....	32
4.3.3	Connecting cable RS 485.....	33
4.3.4	Protocol RS 485.....	33
4.4	Ethernet interface.....	34
4.4.1	Connections via the Ethernet interface.....	34
4.4.2	Configuring the Ethernet interface.....	36
4.4.3	Data transfer rate.....	42
4.4.4	Protocol of the interface.....	43
4.5	Read and write errors on the interfaces.....	43
4.5.1	Write commands of the interface.....	43
4.5.2	Read commands of the interface.....	46
4.5.3	Error messages from the constant temperature equipment to the control station.....	50
4.6	Setting up the circulation thermostat.....	51
4.7	Racks, platforms, rising platforms.....	51
4.8	External consuming unit.....	52
4.8.1	Hoses.....	52
4.8.2	Connecting an external consuming unit.....	54
4.9	Cooling water.....	55
4.9.1	Cooling water requirements.....	55
4.9.2	Connecting the cooling water.....	57
<b>5</b>	<b>Commissioning.....</b>	<b>58</b>
5.1	LAUDA heat transfer liquids.....	58
5.2	Filling the device.....	60
5.3	Changing/draining heat transfer liquid.....	63
5.4	Establishing a mains connection.....	64
5.5	Switching on the device.....	65
5.6	Display buttons.....	65
5.7	Base remote control unit menu structure.....	67
5.8	Setting overtemperature protection $T_{max}$ .....	68
5.9	Setting temperature limits $T_{ih}$ and $T_{il}$ .....	69
5.10	Setting the temperature target value $T_{set}$ .....	70
5.11	Basic settings.....	71
5.11.1	Safety Mode.....	71
5.11.2	Adjusting the volume of signal tones.....	74

5.11.3	Adjusting the display brightness.....	74
5.11.4	Operating mode following a power failure (auto start).....	75
5.11.5	Limiting the current consumption.....	76
5.11.6	Selecting the menu language.....	76
<b>6</b>	<b>Operation.....</b>	<b>77</b>
6.1	General safety instructions.....	77
6.2	Operating modes.....	79
6.3	Setting the pump level.....	79
6.4	Activating and deactivating standby and operation modes.....	79
6.5	Defining the actuating signal limit.....	80
6.6	External control.....	80
6.6.1	Activating external control, deactivating internal control.....	80
6.6.2	Setting the set point offset.....	81
6.7	Programmer.....	82
6.7.1	Basic information.....	82
6.7.2	Starting, interrupting, continuing and ending a program.....	85
6.8	Control parameters.....	86
6.8.1	Control basics.....	87
6.8.2	Overview of internal control parameters.....	89
6.8.3	Overview of external control parameters.....	90
6.8.4	Opening the control menu.....	91
6.8.5	Editing internal control parameters.....	91
6.8.6	Editing external control parameters.....	92
6.9	Calibrating the temperature probe.....	93
6.10	Viewing the device status.....	95
<b>7</b>	<b>Maintenance.....</b>	<b>97</b>
7.1	General safety instructions.....	97
7.2	Maintenance intervals.....	98
7.3	Cleaning the device.....	98
7.4	Cleaning the air-cooled condenser.....	99
7.5	Cleaning the water-cooled condenser.....	99
7.6	Checking the heat transfer liquid.....	101
7.7	Checking the overtemperature protection.....	101
7.8	Checking the low-level protection.....	102
<b>8</b>	<b>Faults.....</b>	<b>104</b>
8.1	Alarms, warnings and errors.....	104
8.2	Alarms.....	104
8.3	Control system warnings.....	105
8.4	Safety system warnings.....	106

	8.5	SmartCool warnings.....	108
<b>9</b>		<b>Decommissioning.....</b>	<b>110</b>
	9.1	General information on decommissioning.....	110
	9.2	Changing/draining heat transfer liquid.....	111
<b>10</b>		<b>Disposal.....</b>	<b>112</b>
	10.1	Disposing of refrigerant.....	112
	10.2	Device disposal.....	112
	10.3	Disposing of packaging.....	112
<b>11</b>		<b>Technical data.....</b>	<b>113</b>
	11.1	General data.....	113
	11.2	Cooling capacity and cooling water.....	116
	11.3	Refrigerant and filling weight.....	119
	11.4	Maximum current consumption and heating output.....	121
	11.5	Pump characteristics.....	122
<b>12</b>		<b>Accessories.....</b>	<b>123</b>
<b>13</b>		<b>General.....</b>	<b>124</b>
	13.1	Copyright.....	124
	13.2	Technical changes.....	124
	13.3	Warranty conditions.....	124
	13.4	Contact LAUDA.....	124
	13.5	Declaration of Conformity and certificates.....	124
	13.6	Product Returns and Clearance Declaration.....	132
<b>14</b>		<b>Glossary.....</b>	<b>133</b>
<b>15</b>		<b>Index.....</b>	<b>135</b>

## 1 Safety

### 1.1 Safety structure of the devices

- The devices can only be operated as intended under the conditions specified in this operating manual. Any other mode of operation is considered to be an unintended use and could compromise the protection warranted by the device.
- The devices are not designed for use in medical applications in accordance with DIN EN 60601-1 and IEC 601-1!
- This operating manual is part of the device. The information in this operating manual must therefore be kept at hand in the immediate vicinity of the device. Be sure to carefully store this copy of the operating manual.



*If this operating manual is lost, contact LAUDA Service Constant Temperature Equipment. You will find the contact information here*  
 ↪ Chapter 13.4 "Contact LAUDA" on page 124.

When operating the device, there is a risk of injury from high and low temperatures, fire and the presence of electrical energy. These risks posed by the device have been mitigated in the design to the extent possible in keeping with the applicable norms. The remaining risk can be reduced using one of the following measures:

- Safety equipment is available for the device. This equipment is critical to the safety of the device. Appropriate maintenance activities must be implemented to ensure the device remains in good working order. The safety fittings for the device are described in this "Safety" chapter.
- Various warning symbols are located on the device. These symbols must be observed without fail. The warning symbols on the device are described in this "Safety" chapter.
- This operating manual contains safety information. This information must be followed at all times.
- Personnel and the protective equipment worn by personnel are also subject to specific requirements. These requirements are described in this "Safety" chapter.

### 1.2 EMC requirements

Table 1: Classification in accordance with EMC requirements

Device	Immunity requirements	Emissions class	Customer power supply
Heating thermostat	Table 2 (Industrial) in accordance with EN 61326-1	Emissions Class B in accordance with CISPR 11	Worldwide No limitation
Device	Immunity requirements	Emissions class	Customer power supply
Low temperature thermostat	Table 2 (Industrial) in accordance with EN 61326-1	Emissions Class B in accordance with CISPR 11	Only for EU Domestic connection value $\geq 100$ A
Low temperature thermostat	Table 2 (Industrial) in accordance with EN 61326-1	Emissions Class B in accordance with CISPR 11	Rest of the world (outside EU) No limitation

### Instructions for Class A digital device, USA

"This equipment has been tested and found to comply with the limits for Class A digital device, pursuant to Part 15 of the FCC (Federal Communication Commission) Rules. These limits are designed to provide reasonable protection against harmful interference when the equipment is operated in a commercial environment. This equipment generates, uses, and can radiate radio frequency energy and, if not installed and used in accordance with the instruction manual, may cause harmful interference to radio communications. Operation of this equipment in a residential area is likely to cause harmful interference in which case the user will be required to correct the interference at his own expense."

### Instructions for Class A digital device, Canada

"This Class A digital apparatus complies with Canadian ICES-003" (ICES = Interference Causing Equipment Standards).

« Cet appareil numérique de la classe A est conforme à la norme NMB-003 du Canada ».

## 1.3 Software versions

These operating instructions are valid for devices with the following software versions or higher.

Software	Valid from version
Command Touch operating system	1.14
Base operating system	1.33
Control system	1.36
Protection system	1.25
Cooling system	1.42
Pump	1.01
Analog IO module	3.14
RS 232/485 module	3.22
Digital IO module	3.14
Solenoid valve	3.06
EtherCAT module	1.06

## 1.4 Observing additional operating instructions

### Interface modules

Additional interface modules can be fitted to the device. Before installing and using interface modules, always read and observe the operating manual accompanying the relevant interface module.

## 1.5 Intended use

This section is relevant for:

- the Bath thermostat device category



## As intended

- The bath thermostat (heating and cooling bath thermostats) may only be used to control the temperature of flammable and non-flammable liquids.
- The heating bath thermostat can be operated using the integral cooling coil. As a result, the heating bath thermostat can be used to cool fluids.
- The thermostat may only be operated with an approved country-specific mains plug for the power supply.

## Unintended

The following types of use are considered unintended:

- Use as a medical device
- Use in potentially explosive areas
- Use for controlling the temperature of foodstuffs

This section is relevant for:

- the Circulation thermostat device category

## As intended

- The circulation thermostat may only be used to recirculate and control the temperature of flammable and non-flammable heat transfer liquids. The heat transfer liquid is pumped through an external circuit with a closed consumer unit and then back into the thermostat.
- The thermostat may only be operated with an approved country-specific mains plug for the power supply.

## Unintended

The following types of use are considered unintended:

- Use as a medical device
- Use in potentially explosive areas
- Use for controlling the temperature of foodstuffs
- Use with a glass reactor without overpressure protection

## 1.6 Foreseeable misuse

The following are considered cases of foreseeable misuse:

- Operating the device without heat transfer liquid
- Connecting hoses incorrectly
- Setting an incorrect pump pressure

## 1.7 Prohibition of modifications to the device

Any technical modification of the device by the user is prohibited. Any damage resulting from unauthorized modification is not covered by customer service or the product warranty. Service work may only be performed by the LAUDA Service department or a service partner authorized by LAUDA.

## 1.8 Materials

This section is relevant for:

- the Bath thermostat device category

All parts of the device that come into contact with heat transfer liquid are manufactured from high-quality materials adapted to withstand the operating temperature. The range of materials used includes high-quality stainless steels and high-quality, temperature-resistant plastics.

This section is relevant for:

- the Circulation thermostat device category

All parts of the device that come into contact with heat transfer liquid are manufactured from high-quality materials adapted to withstand the operating temperature. The range of materials used includes high-quality stainless steels, high-quality, temperature-resistant plastics and brass.

## 1.9 Fluorinated refrigerant

The cooling thermostats are operated with non-odorized refrigerant (fluorinated greenhouse gas), depending on the device model. There are no special installation requirements due to the low refrigerant charge and hermetically sealed design. The designation and refrigerant charge are specified on the rating label.

## 1.10 Natural refrigerant

Some cooling thermostats are operated with non-odorized natural refrigerant, depending on the device model. These refrigerants are combustible. There are no special installation requirements due to the low refrigerant charge and hermetically sealed design. The designation and refrigerant charge are specified on the type plate.



See information  Further information on page 29

## 1.11 Heat transfer liquid requirements

- Heat transfer liquids are used to control the temperature. Only LAUDA heat transfer liquids are approved for use in the device. LAUDA heat transfer liquids are liquids that have been tested and approved by LAUDA DR. R. WOBSE GMBH & CO. KG.
- The device is designed for combustible heat transfer liquids according to class III as per DIN 12876-1.
- The heat transfer liquids are suitable for a specific temperature range. This temperature range must correspond with the temperature range of your application.
- The use of heat transfer liquids poses a risk of injury from high and low temperatures and fire if certain upper or lower temperature thresholds are exceeded or the container is broken, causing a reaction with the heat transfer liquid.
- All possible risks in handling the heat transfer liquid are specified in the safety datasheet for the liquid together with corresponding safety measures. The safety datasheet must therefore be observed in order to use the device as intended.

## 1.12 Hose requirements

The hoses for the external hydraulic circuit must be resistant to:

- the heat transfer liquid used
- the pressure in the hydraulic circuit
- the high and low working temperatures

## 1.13 Application area

The device may only be used in the following areas.

- Production, quality assurance, research and development in an industrial environment
- Internal areas, not suitable for outdoor installation

## 1.14 Personnel qualification

### Operating personnel

Operating personnel are personnel who have been instructed on how to use the device as intended in line with the information in the operating manual.

### Specialized personnel

Certain activities on the device must be performed by specialized personnel. Specialized personnel are personnel whose education, knowledge, and experience qualify them to assess the function and risks associated with the device and its use.

## 1.15 Personal protective equipment

### Protective clothing

Protective clothing must be worn for certain tasks. This protective clothing must meet the legal requirements for personal protective equipment valid in the European Union.

### Safety glasses

Safety glasses must be worn for certain tasks. These safety glasses must meet existing legal requirements for personal protective equipment valid in the European Union.

### Protective gloves

CE protective gloves must be worn for certain tasks. These protective gloves must meet the legal requirements for personal protective equipment valid in the European Union.

## 1.16 Safety fittings on the device

### 1.16.1 Overtemperature protection

The overtemperature protection is a safety fitting that prevents flammable heat transfer liquid from igniting due to high temperatures. All safety components on the device are shut down to prevent fire from posing a danger. An alarm signal also indicates that the overtemperature protection has been activated. The temperature at which the safety fitting is activated must be set in line with the heat transfer liquid used.

We recommend testing the overtemperature protection at regular intervals.



See ↩ Chapter 7.7 “Checking the overtemperature protection” on page 101 for further information.

## 1.16.2 Low-level protection

The low-level protection is a safety unit that prevents damage to the device and prevents the hot heater from igniting combustible heat transfer liquid. If the heat transfer liquid level in the device falls below a specified level (level 2), a warning is issued initially. If the level continues to fall (level 1), an alarm is triggered. All safety components on the device are switched off as a result.

We recommend testing the low-level protection at regular intervals.



See ↩ Chapter 7.8 “Checking the low-level protection” on page 102 for further information.

## 1.17 Warning symbols on the device

### Hot



"Hot surface" warning symbols are affixed to the device. This symbol warns against hot surfaces on the device. These surfaces must not be touched during operation. These surfaces must be allowed to cool to room temperature before they can be touched during other operation phases such as servicing.

This section is relevant for:

- devices containing natural refrigerant

### Flammable



- The warning symbol “Flammable” is attached to devices filled with natural refrigerants.

This symbol warns against the flammability of natural refrigerant.

## 1.18 Warning symbols

### Stickers on devices with NRTL certification



Only operated the device with the casing installed, attached to the back of the device



Flammable heat transfer liquid, attached to the back and top of the device

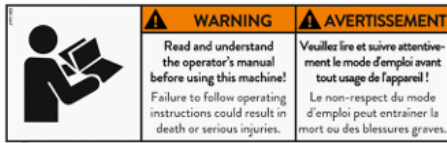

Read the instruction manual, attached to the right-hand side of the device



Wear protective equipment and protective clothing, attached to the right-hand side of the device



Hot or cold surfaces, attached to the right-hand side of the device



Risk of slipping on wet floor, attached to the right-hand side of the device



Disconnect the device from the mains before carrying out (service) work on the device. Attached below the covering plate on the mains switch.

## 1.19 Structure of warnings

Warning signs	Type of danger
	Warning – danger zone.
Signal word	Meaning
DANGER!	This combination of symbol and signal word indicates an imminently dangerous situation that will result in death or serious injury if it is not avoided.
WARNING!	This combination of symbol and signal word indicates a potentially dangerous situation that can result in death or serious injury if it is not avoided.
CAUTION!	This combination of symbol and signal word indicates a possible dangerous situation that can result in minor injury if it is not avoided.
NOTICE!	This combination of symbol and signal word indicates a potentially dangerous situation that can result in material and environmental damage if it is not avoided.

## 2 Unpacking

**DANGER!**  
 Transport damage

	Electric shock
	<ul style="list-style-type: none"> <li>● Closely inspect the device for transport damage prior to commissioning!</li> <li>● Never operate a device that has sustained transport damage!</li> </ul>

The following safety notice is relevant for bath thermostats:



**NOTICE!**  
 Danger of device falling or overturning

	Device damage
	<ul style="list-style-type: none"> <li>● Never lift the device by the component bridge.</li> </ul>

The following instruction is relevant for heat thermostats:

- Hold on under the heat thermostats to lift and carry them.

1. Unpack the device.

*Keep the original packaging of your constant temperature equipment for subsequent transportation.*

2. Check the device and accessories for completeness and transport damage immediately after delivery.



*If the device or accessories are damaged contrary to expectations, immediately inform the shipping company so that a damage report can be compiled and the transport damage inspected. Also notify LAUDA Service Temperature control devices immediately. You will find the contact information here ↪ Chapter 13.4 “Contact LAUDA” on page 124.*

Table 2: Standard accessories for all devices

Device type	Designation	Quantity	Cat. No.
All devices	Operating manual	1	YACD0103
All devices	Base remote control unit	1	LRT 922
Devices with refrigerating machine	Hose nozzle 10 mm outer diameter with screw cap G3/8” internal	2	EOA 078

Table 3: Standard accessories for cooling bath thermostats

Device type	Designation	Quantity	Cat. No.
RP 1090, RP 10100	Bath cover	1	HDQ 154
RP 2040, RP 2045, RP 2090	Bath cover	1	HDQ 157
RP 3035	Bath cover	1	HDQ 156

Table 4: Standard accessories for thermal bath thermostats

Device type	Designation	Quantity	Cat. No.
P 10	Bath cover	1	HDQ 154
P 20	Bath cover	1	HDQ 157
P 30	Bath cover	1	HDQ 156

### 3 Structure and function

#### 3.1 Structure

##### 3.1.1 Structure of the bath thermostat

Front view

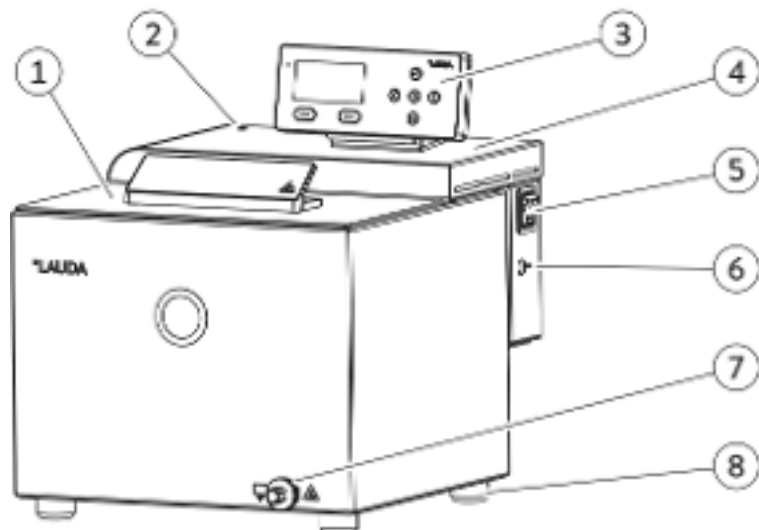

Fig. 1: Thermal bath thermostat, front view

- 1 Bath cover
- 2 Visual operation and fault indicator (LED)
- 3 Base remote control unit
- 4 Component bridge
- 5 Mains switch
- 6 LiBus interface for connecting the operating unit
- 7 Draining nozzle for connecting a hose
- 8 4 feet



Back

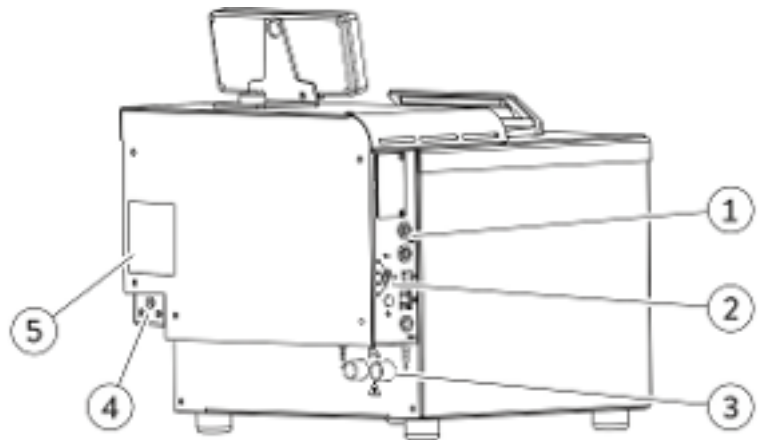

Fig. 2: Thermal bath thermostat, rear view

- 1 Interface panel
- 2 Rotary knob for maximum temperature  $T_{\max}$  and release button
- 3 Bath cooling connection sockets (refrigerant inlet IN; refrigerant outlet OUT)
- 4 Power supply
- 5 Rating label

### 3.1.2 Structure of the circulation thermostats

Front

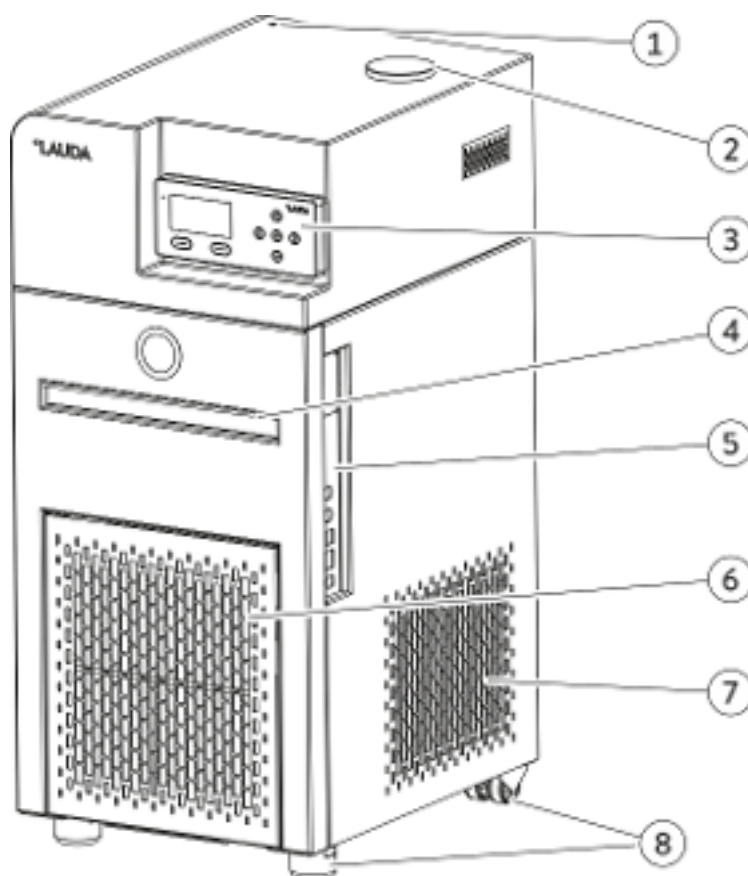

Fig. 3: Circulating thermostat with refrigerating machine, front view

- 1 Visual operation and fault indicator (LED)
- 2 Tank filler neck
- 3 Base remote control unit
- 4 Recessed grip
- 5 Interfaces
- 6 Front panel (detachable)
- 7 Ventilation grid
- 8 Feet at front; castors at rear

Back

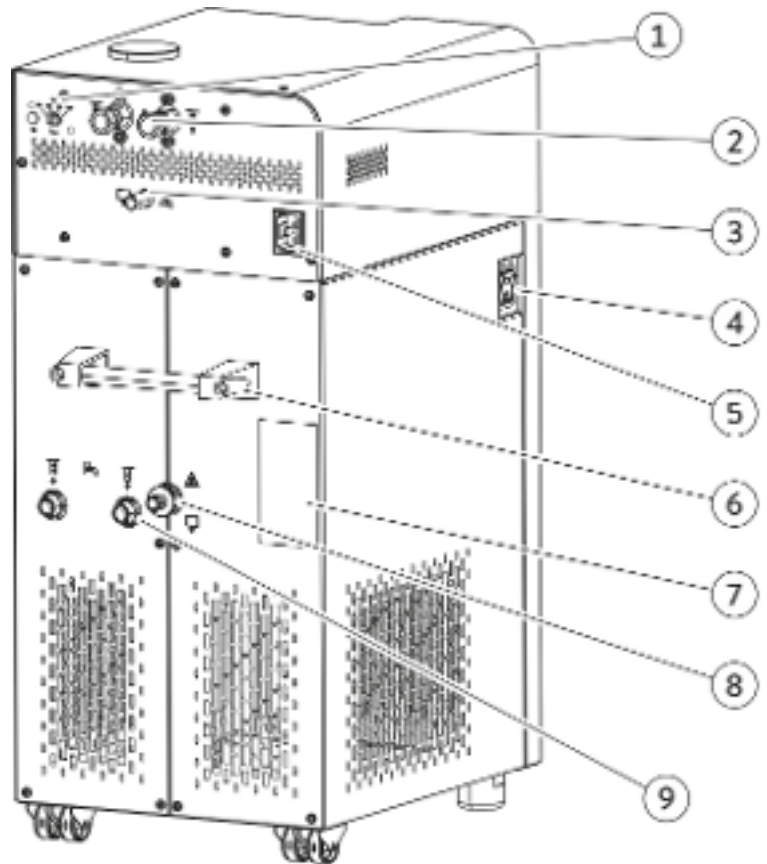

Fig. 4: Circulation thermostat with refrigerating machine, rear view

- 1 Rotary knob for maximum temperature  $T_{\max}$  and release button
- 2 Pump connectors outflow OUT and inlet IN
- 3 Overflow and ventilation of expansion tank
- 4 Mains switch
- 5 Power supply
- 6 Handle
- 7 Rating label
- 8 Draining nozzle for connecting a hose
- 9 Connection sockets for refrigerant inlet IN and refrigerant outlet OUT

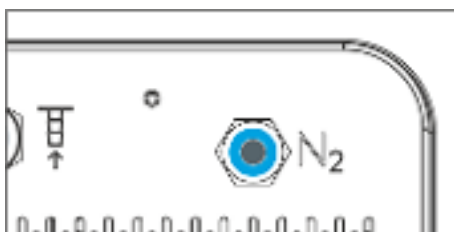

Fig. 5: Nitrogen connection RP 290 E

## 3.2 Operating elements

### 3.2.1 Mains and safety switch



Fig. 6: Mains switch

The mains switch can be set to the following positions:

- Position [I] switches the device on.
- Position [O] switches the device off.

The mains switch also functions as a safety switch.

1. If a fault current occurs, the fuse triggers and the mains switch moves to position [O].
  - ▶ The device is switched off.
2. Pull the mains plug from the power socket.
3. Rectify the mains fault.
4. Plug the mains cable into the power socket and set the mains switch to position [I].
  - ▶ The device starts.



*If the safety switch jumps back to the [O] position, contact LAUDA Service Temperature control devices.*

### 3.2.2 Release button and maximum temperature knob

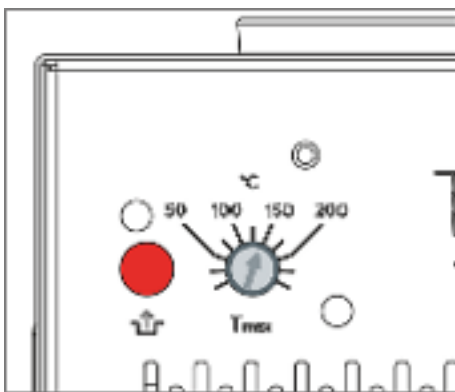

Fig. 7: Release button and T<sub>max</sub> knob

Set the maximum temperature  $T_{\max}$   
Release button

- Rotary knob with scale for setting the maximum permitted temperature [T<sub>max</sub>], adjusted using a screwdriver. Refer to Chapter 5.8 “Setting overtemperature protection T<sub>max</sub>” on page 68 for more information on setting the temperature.
- In the event of a malfunction, press the [Release] button once the fault is rectified.

## 3.3 Functional elements

### 3.3.1 Hydraulic circuit

The hydraulic circuit refers to the circuit that the heat transfer liquid flows through.

The circuit essentially consists of the following components:

- Bath containing heat transfer liquid
- Heater for heating the heat transfer liquid
- Refrigerating machine for cooling the heat transfer liquid

## Pump in the bath thermostat

The bath thermostat is fitted with a variopump (pressure pump) for internal bath circulation. The pump can be set to one of 8 pump levels (may be fewer depending on the device) to optimize bath circulation, noise emissions and mechanical heat input.

The automatic SteadyFlow function for the pump motor allows you to circulate high-viscosity heat transfer liquids at the same flow rate as low-viscosity heat transfer liquids.

The variopump can operate briefly at a maximum viscosity of 150 mm<sup>2</sup>/s. However, 50 mm<sup>2</sup>/s should not be exceeded during regular operation. The ideal temperature controller setting is 30 mm<sup>2</sup>/s or lower.

## Pump in the circulation thermostat

The circulation thermostat is fitted with a powerful vario flex pump (pressure-suction pump) for controlling the temperature of the consuming unit effectively. The pump can be set to one of 8 pump levels (may be fewer depending on the device) to optimize the output, conveyance pressure, noise emissions and mechanical heat input.

The automatic SteadyFlow function for the pump motor allows you to circulate high-viscosity heat transfer liquids at the same flow rate as low-viscosity heat transfer liquids.

The vario flex pump can operate briefly at a maximum viscosity of 150 mm<sup>2</sup>/s. However, 50 mm<sup>2</sup>/s should not be exceeded during regular operation. The ideal temperature controller setting is 30 mm<sup>2</sup>/s or lower.

## Cooling coil in the bath

All heating bath thermostats and heating circulation thermostats are fitted with a cooling coil for internal bath cooling as standard.

- A cooling source such as a fresh water supply can be connected to the cooling coil connection sockets.
- See ↗ Table 42 “Cooling water data” on page 117 for information on inner hose diameters.
- The bath temperature of the thermostat can be decreased to approximately 5 °C above the temperature of the cooling water (without an external consuming unit).
- The LCZ 9771 cooling water valve (with LiBus triggering) available as an accessory only opens the cooling water supply when cooling is required.

## Operating the cooling coil in a central cooling water system



**CAUTION!**  
Operation with cooling coil, discharge of hot steam/boiling cooling water

Scalding

- Only use the cooling coil up to a bath temperature of 95 °C.

The cooling coil is approved for PRO heating thermostats (bath thermostats and circulation thermostats) operated on a central cooling water system up to a bath temperature of 95 °C. In practice, the operating pressures in a central cooling water system vary significantly and the return pipes are not depressurized, which means that the cooling coil does not drain completely when the cooling fluid supply is closed. If temperatures are higher than the boiling point of the cooling water, the high degree of heat lost when the cooling water evaporates in the cooling coil impairs the temperature process enormously. Furthermore, the effect of possible bursts of steam on the central cooling water circuit or connected consuming units should not be underestimated.

### Operating the cooling coil with drinking water



#### WARNING!

Operation with cooling coil, hot steam bursts/hot steam at bath temperatures above 95 °C

#### Scalding

- The open end of the cooling coil hose must be secured to the outlet.

The cooling coil is approved for PRO heating thermostats (bath thermostats and circulation thermostats) operated on a drinking water pipeline with depressurized outlet up to a bath temperature of 155 °C. It is possible to operate the cooling water valve safely with water on a PRO heating thermostat above 100 °C because the cooling water can drain from the cooling coil on the heating thermostat and does not have to evaporate completely first. If the cooling fluid supply opens and cooling water enters the cooling coil at a bath temperature of more than 95 °C, it produces a brief burst of steam, which is why the open end of the cooling coil hose must be secured to the outlet. The hoses leading to and from the cooling coil must slope downwards all the way to the outlet.

The cooling capacity of the bath cooling coil depends on the bath temperature of the thermostat and the temperature of the cooling water. If oil is used as heat transfer liquid instead of water under similar temperature conditions, a slightly lower cooling capacity can be expected. If higher bath temperatures (up to 155 °C) are reached during operation, the cooling capacity increases because of the high thermal gradients between the heat transfer liquid and cooling water.

### 3.3.2 Refrigerating machine

The refrigerating machine consists of the following main components:

- Compressor  
A piston compressor is used in the refrigerating machine. The compressor is protected by a motor protection switch, which reacts to the temperature and current consumption of the compressor. The compressor switches on automatically but can also be activated manually via the control menu. If safety-related faults occur, the refrigerating machine is switched off automatically.
- Evaporator  
A stainless steel tube coil evaporator extracts heat from the internal bath.

- Electronic expansion  
Modern electronic expansion valves expand the refrigerant. Cooling requirements can be controlled with extreme precision using a procedure developed and patented by LAUDA.
- SmartCool system  
A special form of proportional cooling combined with a controlled fan. With proportional cooling, the required cooling capacity is set virtually proportional to the controller signal. Proportional cooling can save up to 75 % energy compared to standard cooling methods that cool and reheat. The automatic cooling unit also switches the refrigerating machine off completely if cooling is not required for a prolonged period.
- SelfCheck assistant  
All parameters and modes for switching off the heating control and sensors are checked before actual operation starts. The system not only displays alarm messages and fault messages, but also notifies the operator of the need to perform maintenance, such as cleaning the air-cooled condenser.



*The refrigerating machines may contain natural refrigerant, depending on the model. These refrigerants are combustible.*



*The refrigerating machines may contain fluorinated refrigerant, depending on the model.*

*Refer to ↗ Chapter 11.2 “Cooling capacity and cooling water” on page 116 for technical specifications relating to the different cooling thermostats.*

### 3.3.3 Heat discharge through cooling in a hybrid design

#### Hybrid cooling

The heat of the refrigerating machine is discharged by a combined air and water cooling system. The user can cool using either air or water at any time. If the user opens the cooling water supply to the device while the device is operating, the system switches automatically from air cooling to water cooling. If the cooling water system does not discharge enough heat energy, the device switches on air cooling automatically as a supporting measure.

- In air-cooled mode, the device is cooled with air, whereby the fan draws in fresh air through the front of the device. The fresh air heats up inside the device and is discharged at the sides and back of the device.
- In water-cooled mode, the heat is discharged via the cooling water circuit. On the standard version of the device, the cooling water volume is unregulated, but can be controlled by adding the accessory “cooling water valve” (on/off).
- The fan on the air-cooled condenser must also operate at a low speed for the compressor to cool.



*The cooling water must be a minimum of 5 – 10 K cooler than the ambient temperature of the device to ensure efficient cooling.*

### 3.3.4 Nitrogen overlay

This section is relevant for device RP 290 E.

The nitrogen overlay ...

- is guided directly over the surface of the heat transfer liquid in the circulation thermostats. The nitrogen flows out through the device overflow.
- reduces the condensation of moisture in the heat transfer liquid.
- reduces oxidation of the heat transfer liquid.
- increases the service life of the heat transfer liquid.
- decreases the flammability of combustible heat transfer liquids.

Please note:

- An overflow hose with collecting vessel must be connected to the overflow of the circulation thermostat, see [Chapter 4.8.2](#) “Connecting an external consuming unit” on page 54.  
An excessive nitrogen flow rate may cause heat transfer liquid to be drawn through the circulation thermostat overflow.
- The nitrogen overlay must not be used in closed rooms. The operating areas must be well ventilated. Alternatively, use an extraction system.
- Ignition sources must be avoided at the filling opening and overflow if heat transfer liquids are operated near their flash point temperature.

### Connection

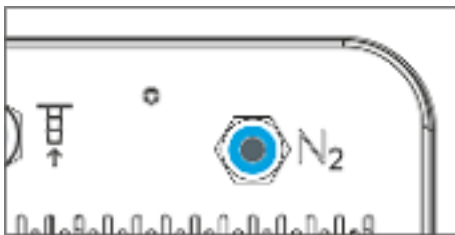

Fig. 8: Nitrogen connection (N<sub>2</sub>)

Push-in connection on the rear of the device that can be operated without tools, compatible with 6 mm pneumatic hoses (Teflon, PE), LAUDA Article No. RKJ 048. The push-in connection is automatically closed when the hose is not inserted.

**Installation:** Simply insert the hose into the connection.

**Removal:** Push the blue ring and then simply pull out the hose.

### Adjusting the flow rate

A gas dosing device is required to adjust the nitrogen flow rate. The dosing device is not included in the delivery. A pressure reducer with outflow tap can be used as a dosing device, for example.

- A nitrogen flow rate of 0.5 – 5 liters per hour is recommended.

### 3.3.5 Series standard and optional interfaces

The following sections contain a general overview of all standard interfaces on the device as well as additional interface modules.



Equipment connected to the low-voltage inputs and outputs must be safely insulated against dangerous contact voltages as per DIN EN 61140, for example, using double or reinforced insulation as per DIN EN 60730-1 or DIN 60950-1.



Refer to the separate operating manual accompanying the interface modules for further information on installing and operating these interface modules. Each respective operating manual must be observed in order to use the module as intended.



## Standard interfaces

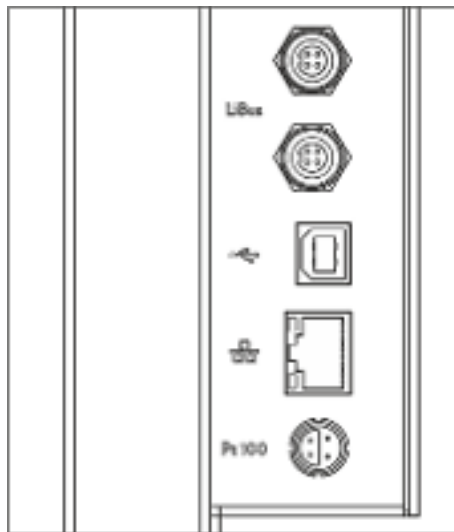

Fig. 9: Interface panel

- The Base or Command Touch remote controls are connected via the **LiBus interface** (marked with designation LiBus).
- The **USB device interface** (type B) allows connection to a PC. Software updates are transferred to the device via this USB interface (for updaters only, not a process interface).
- The **Ethernet interface** offers the customer the opportunity to control and monitor the temperature processes carried out by LAUDA constant temperature equipment through a LAUDA interface command set (process interface).
- The external Pt100 temperature probe is connected to the **Pt100 interface** (marked with the label Pt100). This interface is a LEMO socket in size 1S.

## Additional interfaces

Additional interface modules can be installed in the devices.

- The **Analog module** (order no. LRZ 912) has a 6-pin DIN socket with two inputs and two outputs. The inputs and outputs can be configured as a 0 – 20 mA, 4 – 20 mA or 0 – 10 V interface independently of one another. A voltage of 20 V applied to the socket supplies power to an external sensor with electronic evaluation unit.
- The **RS 232/485 interface module** (order no. LRZ 913) is available in a 9-pin SUB-D socket design. Galvanically isolated by an optocoupler. When combined with the LAUDA command set, the module is compatible with the ECO, Variocool, Proline, Proline Kryomat, PRO, Integral XT and Integral T product lines. The RS232 interface can be connected directly to the PC using a 1:1 contacted cable.
- The **contact module** (order no. LRZ 914) is available in a plug connector design according to NAMUR NE28. This contact module is identical to LRZ 915, but only has two DIN sockets, each with one output and one input. The coupling socket (order no. EQD 047) and the coupling connector (order no. EQS 048) have a 3-pin design.
- The **contact module** (order no. LRZ 915) is available in a 15-pin SUB-D socket design. The module has three relay contact outputs (changeover contacts, maximum 30 V/ 0.2 A) and three binary inputs for control via external floating contacts.
- **Profibus module** (order no. LRZ 917). Profibus is a bus system used primarily in the chemical industry, which can connect a maximum of 256 devices at a high signal transmission rate.
- **EtherCAT module** (order no. LRZ 922) with M8 connection sockets. **EtherCAT module** (catalog no. LRZ 923) with connection via RJ45 sockets. EtherCAT is an Ethernet-based fieldbus with master/slave functionality.
- External **LiBus module box** (order no. LCZ 9727) with two additional module bays. The number of LiBus interfaces can be increased using the LiBus module box (LCZ 9727). Additional modules such as a solenoid valve for regulating the cooling water or a reverse flow protection can subsequently be connected.

Refer to the operating manual accompanying the relevant LAUDA interface module for further information on connecting and using these interfaces.

### 3.4 Rating label



Fig. 10: Rating label (example)

The specifications on the rating label are described in more detail in the following table. Certain specifications depend on the device type and the installed equipment.

Angabe	Description
Type:	Device type
Order No.:	Order number of the device
Serial No.:	Serial number of the device
Refrigerant I:	Designation of the refrigerant used in the refrigerating machine, level 1
Filling charge I:	Filling charge of the refrigerant in the refrigerating machine, level 1
PS high pressure I:	Maximum permitted working pressure at the refrigerant high-pressure side in the refrigerating machine, level 1
PS low pressure I:	Maximum permitted working pressure at the refrigerant low-pressure side in the refrigerating machine, level 1
Refrigerant II:	Designation of the refrigerant used in the refrigerating machine, level 2
Filling charge II:	Filling charge of the refrigerant in the refrigerating machine, level 2
PS high pressure II:	Maximum permitted working pressure at the refrigerant high-pressure side in the refrigerating machine, level 2
PS low pressure II:	Maximum permitted working pressure at the refrigerant low-pressure side in the refrigerating machine, level 2
Voltage:	Device may only be operated with this distribution voltage and frequency
Current consumption:	Maximum current consumption of the device during operation
Protection class:	IP protection level of the device
Class acc. to DIN 12876-1:	German standard for electrical laboratory equipment

LAUDA	
Made in Germany	
Type:	RP 298 E NRTL
Order No.:	L002659
Serial No.:	S210008534
Refrigerant I:	R-452A (GWP 2140)
Filling charge I:	300 g; 0,64 l CO <sub>2</sub> -eq
PS high pressure I:	20 bar
PS low pressure I:	19 bar
Refrigerant II:	R-170 (flammable)
Filling charge II:	70 g
PS high pressure II:	20 bar
PS low pressure II:	14 bar
Voltage:	208-220 V; 60 Hz
Current consumption:	16 A
Protection class:	IP 21
Class acc. to DIN 12876 L:	III / FL
Contains fluorinated greenhouse gases	
SOCR:	5 kA
Compressor FLA I:	4,7 A
Compressor HP I:	1,3 HP
Compressor FLA II:	2,9 A
Compressor HP II:	0,9 HP
Pump FLA I:	---
Pump HP I:	---
Pump FLA II:	---
Pump HP II:	---
Refrigeration for FLA:	---
Refrigeration for HP:	---
   	
LAUDA DR. R. WÖBSE GMBH & CO. KG 97922 Lauda-Königshofen, La. deplatz 1, Germany	

The images show examples of rating labels for devices with NRTL certification.

Fig. 11: Rating label for a low-temperature thermostat (example)



Fig. 12: Rating label for a heating thermostat (example)

Specification	Description
SCCR:	Indicates the short-circuit current according to NEC 110-10 or UL508A which the components and assemblies used in the machine can withstand
Compressor FLA I:	Current consumption of Compressor I under full load
Compressor HP I:	Power of Compressor I in horse power
Compressor FLA II:	Current consumption of Compressor II under full load
Compressor HP II:	Power of Compressor II in horse power
Pump FLA I:	Current consumption of Pump I under full load
Pump HP I:	Power of Pump I in horse power
Pump FLA II:	Current consumption of Pump II under full load
Pump HP II:	Power of Pump II in horse power
Refrigeration fan FLA:	Current consumption of the fan under full load
Refrigeration fan HP:	Power of the fan in horse power



Values (HP and FLA) for the compressor, pump and refrigeration fan are only provided on the rating label for components with a performance class over 0.75 HP. For components with a performance class under 0.75 HP, no values (HP and FLA) are provided on the rating label.

## 4 Before starting up

### 4.1 Installation



**WARNING!**  
Danger of device falling or overturning

Crushing, impacts

- Do not tilt the device.
- Position the device on an even, non-slip surface with a sufficient load carrying capacity.
- Do not position the device close to table edges.

The following instruction is relevant for heat thermostats:

- Hold on under the heat thermostats to lift and carry them.

The following safety notice is relevant for devices with a refrigerating machine:



**WARNING!**  
Danger of overpressure from high ambient temperature

Injury, escape of refrigerant

- Note the permitted ambient temperature.

The following safety notices are relevant for devices containing natural refrigerant:



**WARNING!**  
Explosive gas mixture resulting from leakage in refrigerant circuit

Fire, explosion

- Devices containing less than 150 g of combustible refrigerant are not subject to special installation conditions. However, a minimum volumetric flow of 1 m<sup>3</sup> for every 8 g of refrigerant is recommended.



**WARNING!**  
Collection of refrigerant in an installation space similar to a trough

Fire, explosion

- Installation of the device in a space similar to a trough is not permitted.

The following safety notice is relevant for bath thermostats:



**NOTICE!**  
Danger of device falling or overturning

Device damage

- Never lift the device by the component bridge.

Please note:

- Irritant vapors may develop, depending on the heat transfer liquid and operating mode used. Always ensure that the vapors are adequately extracted. Use the bath cover for bath thermostats.
- Note the electromagnetic compatibility (EMC) requirements of the device. Refer to [↗ Chapter 1.2 “EMC requirements”](#) on page 7 for more information.

Observe the information relating to devices with a refrigerating machine:

- The device can be operated at a maximum ambient temperature of 40 °C.
- A higher ambient temperature may have a negative impact on the cooling output of the thermostats used.
- After a prolonged period of inactivity, it may take the cooling thermostat up to 30 minutes to reach the nominal cooling output, depending on the room temperature and device type.
- After transporting the refrigeration device, install 2 hours before commissioning if possible so that any displaced oil can flow back into the oil sump and the compressor is not damaged.



*The type and refrigerant charge are printed on the type plate.*

1. Position the device on a table in a suitable space.
2. Keep the device away from other objects and the wall [↗ Chapter 11.1 “General data”](#) on page 113.

Do not cover the ventilation openings.

## 4.2 Installing interface modules

The device can be upgraded with an optional interface module, which is inserted into the side of the device (dimensions of module bay opening 51 mm x 27 mm).

Additional modules can be inserted into the LiBus module box (LCZ 9727). The LiBus module box incorporates two module bays and is available as an accessory.



*Refer to [↗ Chapter 3.3.5 “Series standard and optional interfaces”](#) on page 24 for more information on interface modules.*



## WARNING!

Touching pieces charged with voltage when installing the modules

Electric shock

- Disconnect the device before installing modules.

Description for installing an interface module

1. Touch the grounded bare stainless steel panels on the constant temperature equipment in order to discharge any possible electrostatic charge.
2. Turn off the constant temperature equipment and pull out the mains plug.
3. Remove the module from its packaging.
4. The module bays are protected with a cover. Carefully remove the cover.
5. Carefully remove the bus connection cable from the cover.
6. Insert the bus connection cable (red plug with red socket).



*The plug and the socket are reverse polarity protected.*

7. Insert the module into the bay and fasten it with the two cross-head screws.
  - ▶ The interface module is ready for use.

## 4.3 RS 232 interface

### 4.3.1 Cable and test of the RS 232 interface

Signal	Computer				Thermostat		Signal
	9-pin sub-D socket		25-pin sub-D socket		9-pin sub-D socket		
	With hardware handshake	Without hardware handshake	With hardware handshake	Without hardware handshake	With hardware handshake	Without hardware handshake	
RxD	2	2	3	3	2	2	TxD
TxD	3	3	2	2	3	3	RxD
DTR	4		20		4		DSR
Signal ground	5	5	7	7	5	5	Signal ground
DSR	6		6		6		DTR
RTS	7		4		7		CTS
CTS	8		5		8		RTS

With hardware handshake: When connecting a thermostat to the PC, use a 1:1 cable (not a null modem cable). The RS 232 interface can be connected directly to the PC using a 1:1 contacted cable.

Without hardware handshake: Set the corresponding operation mode on the PC.

Note the following instructions:

- Use protected connection lines.
- Connect the protective screen with the connector shell.
- The lines are galvanically separated from the rest of the electronics.
- Do not connect unassigned pins.

It is easy to check the RS 232 interface when it is connected to a PC with a Microsoft Windows operating system.

- For Windows® 3.11 with the program "Terminal".
- For Windows® 95/98/NT/XP with the program "HyperTerminal".

For the operating systems Windows Vista, Windows 7, and Windows 8, "HyperTerminal" is no longer part of the operating system.

- Terminal programs are available for download from the Internet for free. These programs offer features similar to "HyperTerminal" (for example PuTTY or RealTerm). Search query "serial port terminal program".

#### 4.3.2 Protocol RS 232

Note the following instructions:

- Connection to SUB-D socket 9-pin
- The interface works with 1 stop bit, without a parity bit and with 8 data bits.
- Transmission speed alternately: 2400, 4800, 9600 (factory setting) or 19200 bauds.
- The RS 232 interface can be operated with AND without hardware handshake (RTS/CTS). In order to do so, Pin 4 (DSR) and Pin 6 (DTR) and Pin 7 (CTS) and Pin 8 (RTS) must be connected with a bridge.
- The command from the computer must be made with a CR, CRLF, or LFCR.
- The response from the thermostat is always made with a CRLF.
- After each command sent to the thermostat, it is necessary to wait for the reply before sending another command. This ensures that the sequencing of inquiries and answers is clear.  
CR = Carriage Return (Hex: 0D); LF = Line Feed (Hex: 0A)

Table 5: Example for set value transfer from 30.5 °C to the thermostat.

Computer	Thermostat
"OUT_SP_00_30.5"CRLF	⇒
⇐	"OK"CRLF



### 4.3.3 Connecting cable RS 485

#### Connection RS 485

Thermostat with 9-pin sub-D socket	
Contact	Data
1	Data A (-)
5	SG (Signal Ground) optional
6	Data B (+)

Note the following instructions:

- Use protected connection lines.
- Connect the protective screen with the connector shell.
- The lines are galvanically separated from the rest of the electronics.
- Do not connect unassigned pins.

#### Termination

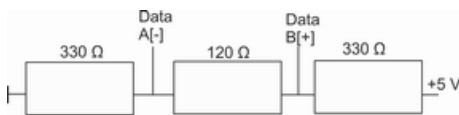

Fig. 13: RS 485 termination

An RS 485 bus **always** requires a bus connection in the form of a termination network that guarantees a defined standby state in the high-ohm phases of bus operation. The bus connection looks like this:

This termination network is usually integrated in the insertable PC card (RS 485) and activated via jumpers.

### 4.3.4 Protocol RS 485

Note the following instructions:

- The interface works with 1 stop bit, without a parity bit and with 8 data bits.
- Transmission speed alternately: 2400, 4800, 9600 (factory setting) or 19200 baud.
- The device address always precedes the RS 485 commands. Up to 127 addresses are possible. The address must always consist of three digits (A000.... to A127....).
- The command from the computer must be made with a CR.
- The response from the thermostatic circulator is always made with a CR.

CR = Carriage Return (Hex: 0D)

Example with set point transfer of 30.5 °C to the thermostatic circulator. In this example, the address 15 is used.

Computer	Thermostatic circulator
"A015_OUT_SP_00_30.5" CR	➔
➔	"A015_OK" CR

## 4.4 Ethernet interface

### 4.4.1 Connections via the Ethernet interface

Various methods can be used to connect LAUDA constant temperature equipment to a control station/PC. The control station can be used to monitor and control the constant temperature equipment.

#### Connected via Ethernet cable

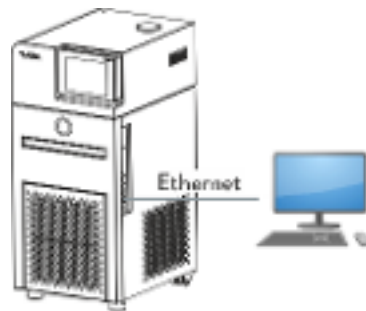

Fig. 14: Connected via Ethernet cable

Fig. 14 illustrates direct communication between the LAUDA constant temperature equipment and the control station/PC via an Internet cable.

Advantage of this connection:

- A network is not required.

#### Connected via LAN

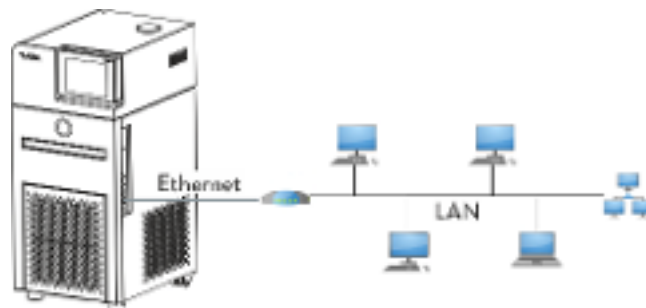

Fig. 15: Connected via LAN

Fig. 15 illustrates how the constant temperature equipment is connected to a control station/PC via a LAN network.

Advantages of this connection:

- The constant temperature equipment can be controlled by any control station/PC.
- It cannot be controlled simultaneously by two control stations/PCs.

## Connected via LAN and WLAN



Fig. 16: Connected via LAN and WLAN

Fig. 16 illustrates the connection between the LAUDA constant temperature equipment and a LAN network with control station via a WLAN. Here, the constant temperature equipment is connected to a WLAN router using a standard Ethernet cable. The WLAN router must be configured so that it establishes a connection to a LAN via another WLAN router. This kind of connection is called a WLAN bridge. Refer to the instructions accompanying the relevant router for information on configuring WLAN routers.

It cannot be controlled simultaneously by two control stations.

Advantages of this connection:

- The constant temperature equipment can be controlled by any control station/PC.
- The constant temperature equipment can be contacted by radio and operated from a remote location.

## Connected via WLAN

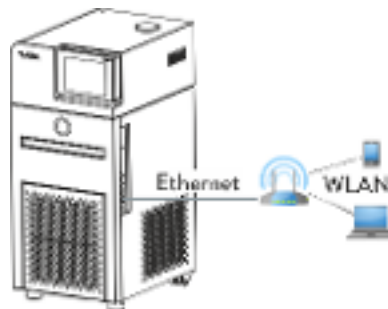

Fig. 17: Connected via WLAN

Fig. 17 illustrates direct communication between the control station/PC and the LAUDA constant temperature equipment via a WLAN. The WLAN router must be configured as an access point. Refer to the instructions accompanying the router for information on configuring the WLAN router.

Advantages of this connection:

- The constant temperature equipment can be contacted by radio and operated from a remote location.
- It is possible to use a short Ethernet cable.
- No LAN network required.

## Notes

- Commercially available WLAN routers can be used for the connections displayed in Fig. 16 and Fig. 17. The routers must have the necessary connection function and meet the requirements in the relevant country in which they are operated. However LAUDA recommends using an industrial WLAN router for the configuration illustrated in Fig. 16.

## 4.4.2 Configuring the Ethernet interface

### Technical data of the Ethernet interface

Data	Value	Unit
Ethernet - standard	10/100	MBit

A glossary with all the relevant explanations appears at the end of the document.

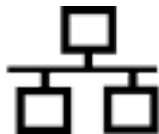

### PC control

- The *PC control* menu item enables the control for a PC or control station. You can activate this function if you wish to control and monitor the thermostat from a control station.

Before the constant temperature equipment and control station can be operated together in a local network (LAN), the Ethernet interface must be configured.

The Ethernet interface can be configured in two different ways:

- |  |  |
|--|--|
| Automatically obtain LAN configuration | - In order for this to work, a DHCP server must be present in the local network (LAN). If communication is direct, the control station must support the auto IP standard.        |
| Manually configure LAN configuration   | - Manual configuration must be performed if a DHCP server is not available, auto IP standard is not supported or you wish to use the Ethernet interface with fixed IP addresses. |

### Manually configure LAN configuration

1. Switch on the constant temperature equipment.
2. Press any button on the Base unit to display the Home window.
3. Press the [input button] to open the menu.
4. Select the menu items from *Settings* → *Basic settings* → *Ethernet* → *LAN settings* → *DHCP client* using the cursor keys and press [OK] to confirm.
  - ▶ The options [off] and [on] appear on the display.
5. Select the option [Off] and press [OK] to confirm.
  - ▶ The *Local IP address* window opens. The cursor marks the input field.
6. Press [OK] to confirm the input field.
  - ▶ The *Local IP address* input window opens.
7. Enter the numerical values, for example 120.0.0.13. The numerical values are entered byte by byte. From left to right, from byte 4 to byte 1. Press [OK] to confirm each byte.

8. Once you have entered the numerical values, press the [Apply] softkey.
  - ▶ The [Local mask] input window opens.
9. Enter the numerical values. The numerical values are entered byte by byte. From left to right, from byte 4 to byte 1. Press [OK] to confirm each byte.
10. Once you have entered the numerical values, press the [Apply] softkey.
  - ▶ The [DHCP client] window opens.
11. Scroll to the numerical values of the [Gateway] menu item and press [OK] to confirm.
12. Enter the numerical values. The numerical values are entered byte by byte. From left to right, from byte 4 to byte 1. Press [OK] to confirm each byte.



*If you do not know the numerical values, ask someone in your IT department for the relevant values. If the wrong numerical values are entered, [Local mask] cannot be completed.*

13. Once you have entered the numerical values, press the [Apply] softkey.
  - ▶ The numerical values entered in [Local IP address], [Local mask] and [Gateway] are displayed.
14. Press the left cursor button to move up one menu level in the PC control menu item and press [OK] to confirm.
  - ▶ The options [No] and [Yes] appear on the display.
15. Select the option [Yes] and press [OK] to confirm.
  - ▶ The PC can now be controlled from the control station.
16. Switch off the constant temperature equipment.
17. Connect the Ethernet interface on the constant temperature equipment as illustrated in Fig. 15 to Fig. 17. Use a commercially available Ethernet cable (patch cable).
18. Switch on the constant temperature equipment.
19. Test the connection with ↵ “Checking the LAN network” on page 38 or ↵ “Check the LAN network and the process interface” on page 39.



*Set the [DHCP client] from [On] to [Off], all numerical values are reset to 0. 0. 0. 0.*





*Use the same procedure (enter LAN settings manually) if there is a **switch** between the constant temperature equipment and PC.*





*When configuring direct Ethernet communication between the control station and the constant temperature equipment, it may take 1 or 2 minutes to establish the connection.*

## Automatically obtain LAN configuration

1. Switch on the constant temperature equipment.
2. Press any button on the Base unit to display the Home window.
3. Press the [input button] to open the menu.
4. Select the menu items from *Settings* → *Basic settings* → *Ethernet* → *LAN settings* → *DHCP client* using the cursor keys and press [OK] to confirm.
  - ▶ The options [off] and [on] appear on the display.
5. Select the option [On] and press [OK] to confirm.
  - ▶ The DHCP client is active. The Ethernet interface is configured automatically.
6. Select the entry [Yes] in the [PC control] menu.
  - ▶ The PC can now be controlled from the control station.
7. Switch off the constant temperature equipment.
8. Connect the Ethernet interface on the constant temperature equipment as illustrated in Fig. 15 to Fig. 17. Use a commercially available Ethernet cable (patch cable).
9. Switch on the constant temperature equipment.
10. Test the connection with  “Checking the LAN network” on page 38 or  “Check the LAN network and the process interface” on page 39.

## Checking the LAN network

1. Start the Windows command processor by entering `cmd.exe`  on the PC with Microsoft Windows operating system.
  - ▶ The entry window will open.
2. There are two ways of checking:
  - Enter the ping command together with the IP address.  
`ping xxx.xxx.xxx.xxx`   
For "XXX.XXX.XXX.XXX", put the IP address that was entered when the Ethernet interface was configured.  
Or
  - Enter the ping command together with the serial number of the thermostatic circulator (possible with software control system 1.36 or later).  
`ping serial number` 
  - ▶ If the Ethernet interface is configured and connected correctly, the interface will return four responses within a very short time. See Fig. 18.

```

Administrator: C:\Windows\system32\cmd.exe
Microsoft Windows [Version 6.1.7601]
Copyright (c) 2009 Microsoft Corporation. Alle Rechte vorbehalten.

C:\Users\Knoll>ping 172.17.20.22

Ping wird ausgeführt für 172.17.20.22 mit 32 Bytes Daten:
Antwort von 172.17.20.22: Bytes=32 Zeit=1ms TTL=64
Antwort von 172.17.20.22: Bytes=32 Zeit<1ms TTL=64
Antwort von 172.17.20.22: Bytes=32 Zeit<1ms TTL=64
Antwort von 172.17.20.22: Bytes=32 Zeit<1ms TTL=64

Ping-Statistik für 172.17.20.22:
    Pakete: Gesendet = 4, Empfangen = 4, Verloren = 0
    (0% Verlust),
    Ca. Zeitangaben in Millisek.:
    Minimum = 0ms, Maximum = 1ms, Mittelwert = 0ms

C:\Users\Knoll>
    
```

Fig. 18: Example for entering the ping command

### Check the LAN network and the process interface

It is easy to check the connection to the interface with a PC and Microsoft Windows operating system.

- For Windows 3.11 with the program "Terminal".
- For Windows 95/98/NT/XP the program "HyperTerminal".
- For operating systems Windows Vista, Windows 7, Windows 8 and Windows 10 "HyperTerminal"\* is not part of the operating system.



\*Terminal programs are available on the Internet as freeware. These programs offer features similar to "HyperTerminal" (for example PuTTY or RealTerm). Search query "serial port terminal program".

### Checking with RealTerm

1. Open the program "HyperTerminal" or the "terminal program" on a PC with Microsoft Windows operating system.
  - ▶ The entry window will open.

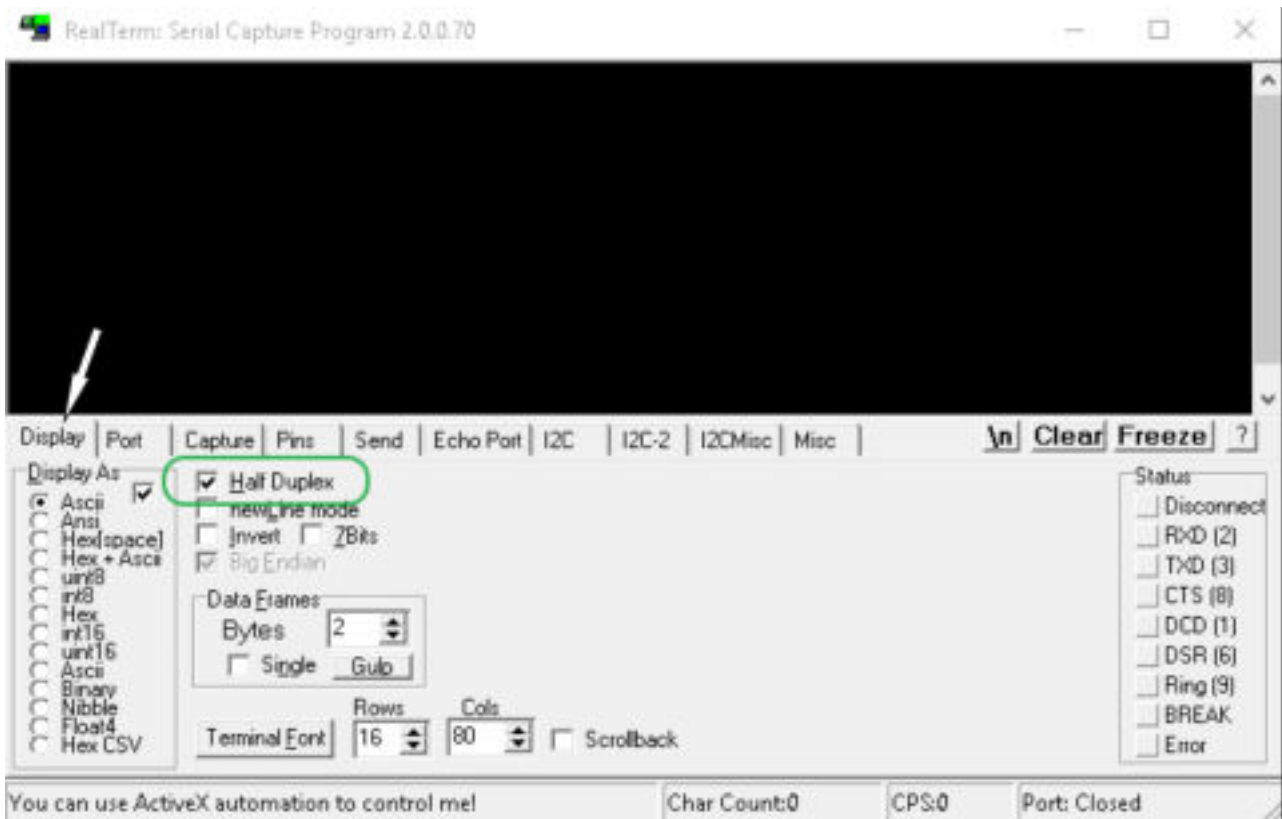

Fig. 19: "RealTerm" program

2. Place a checkmark under *Half Duplex* in the *Display* tab.



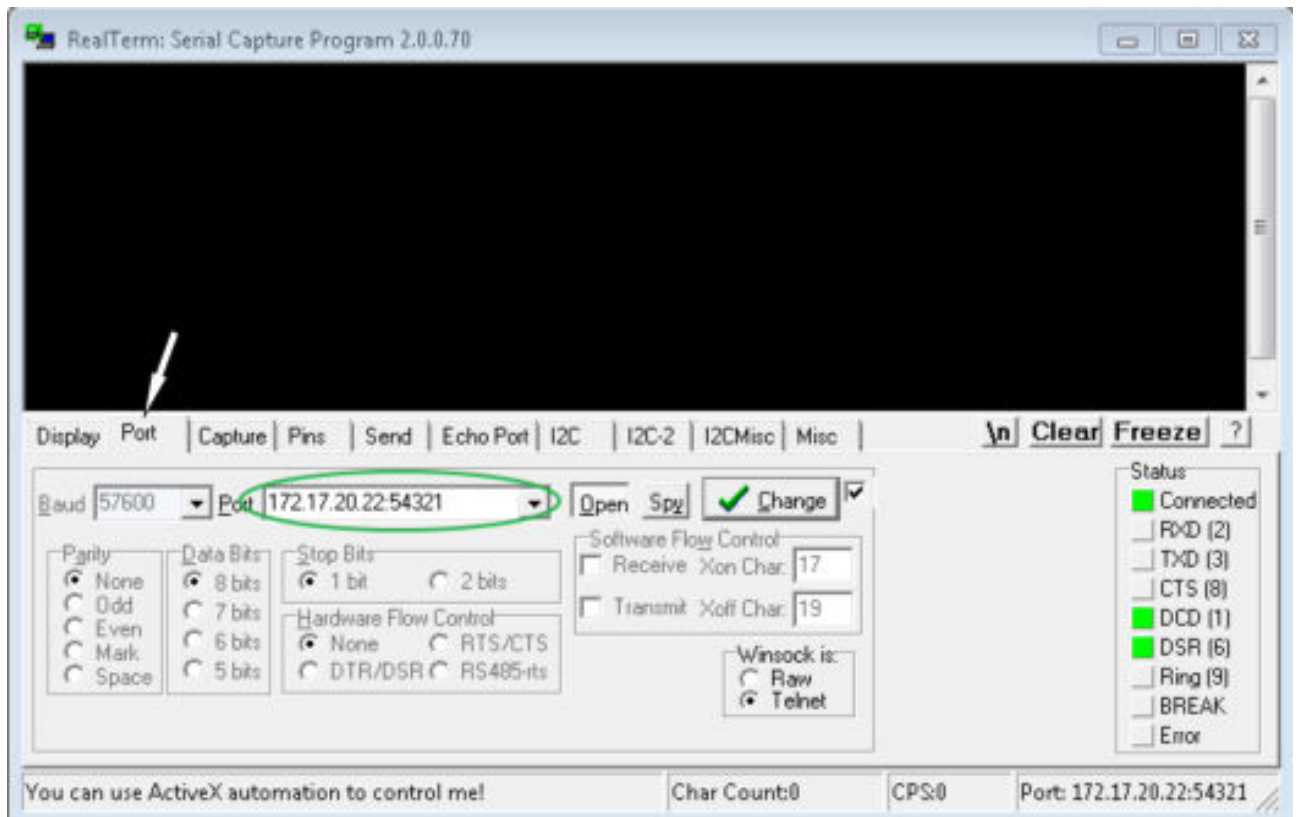

Fig. 20: Entry in the Port field

3. Enter the configured IP address and port number of the Ethernet interface on the constant temperature equipment in the *Port* tab. When you are doing this, be sure that the IP address and port number are separated by a colon.

You can enter the serial number of the constant temperature equipment instead of the IP address.

4. Then press the [Open] button.
5. Open the *Send* tab.
  - ▶ Now that the program has been configured, the actual test can begin.
6. Place a checkmark under *+CR* and *+LF*.

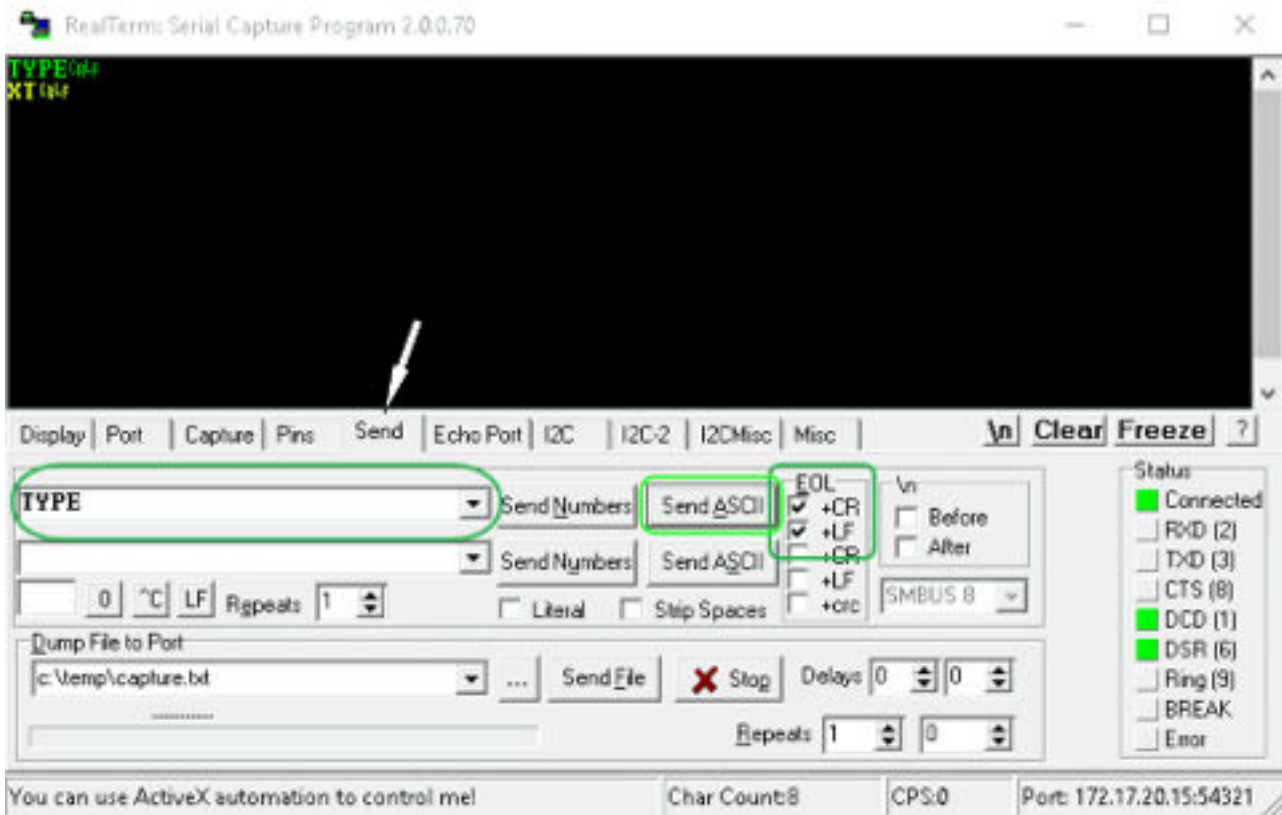

Fig. 21: Entries for the test

7. A command must be sent to the constant temperature equipment to test communication. For example, TYPE. Type the command and press [Send ASCII].
  - ▶ If the connection is operational, the constant temperature equipment acknowledges the command.

#### 4.4.3 Data transfer rate

The data transfer rate cannot be precisely defined. It depends on a variety of different factors:

- Are the constant temperature equipment ( with the Ethernet interface) and the control station/PC on the same network?
- Are the control station/PC and constant temperature equipment connected wirelessly (WiFi) or through a cable?
- What is the load on the network?

Generally commands can be sent to the constant temperature equipment every 500 ms. For WiFi connections the period could exceed 1 s. A new command can only be sent if the previous command has been acknowledged by the constant temperature equipment.

#### 4.4.4 Protocol of the interface

Note the following instructions:

- The command from the computer must be made with a CR, CRLF, or LFCR.
- The response from the thermostatic circulator is always made with a CRLF.
- After each command sent to the thermostat, it is necessary to wait for the reply before sending another command. This ensures that the sequencing of inquiries and answers is clear.  
CR = Carriage Return (Hex: 0D); LF = Line Feed (Hex: 0A)

Table 6: Example with set point transfer of 30.5 °C to the thermostatic circulator

Computer	Temperature control device
"OUT_SP_00_30.5"CRLF	➔
➔	"OK"CRLF

#### 4.5 Read and write errors on the interfaces

##### 4.5.1 Write commands of the interface

Valid for the Ethernet interface and for the RS 232/485 interface module

A write error is a command from the control station to the constant temperature equipment.

Table 7: Temperature

ID	Function	Unit	Command
1	Temperature set point	[°C]	OUT_SP_00_XXX.XX
15	Actual value of external temperature (via interface)	[°C]	OUT_PV_05_XXX.XX
26	Limitation of outflow temperature TiH (upper limit)	[°C]	OUT_SP_04_XXX
28	Limitation of outflow temperature TiH (lower limit)	[°C]	OUT_SP_05_XXX
32	Temperature set point $T_{set}$ in Safety Mode	[°C]	OUT_SP_07_XXX.XX

Table 8: Pump

ID	Function	Unit	Command
17	Pump power stage (device-specific, e.g. 1 - 6 or 1 - 8)	[-]	OUT_SP_01_[Value]

Table 9: Cooling

ID	Function	Unit	Command
23	Cooling mode: 0 = Off / 1 = On / 2 = Automatic	[-]	OUT_SP_02_[Value]

Table 10: Safety

ID	Function	Unit	Command
34	Timeout communication via interface (1 - 99 seconds; 0 = Off)	[s]	OUT_SP_08_[Value]
72	Activate Safety Mode = 1 Safe operating statuses of the device in the event of a fault are defined in Safety Mode. These operating statuses must be entered by the user beforehand.	[-]	OUT_MODE_06_1

Table 11: Control parameters

ID	Function	Unit	Command
38	Control parameter Xp	[-]	OUT_PAR_00_XX.X
40	Control parameter Tn (5– 180 s; 181 = Off)	[s]	OUT_PAR_01_XXX
42	Control parameter Tv	[s]	OUT_PAR_02_XXX
44	Control parameter Td	[s]	OUT_PAR_03_XX.X
46	Control parameter KpE	[-]	OUT_PAR_04_XX.XX
48	Control parameter TnE (0– 9000 s; 9001 = Off)	[s]	OUT_PAR_05_XXXX
50	Control parameter TvE (5 = Off)	[s]	OUT_PAR_06_XXXX
52	Control parameter TdE	[s]	OUT_PAR_07_XXXX.X
54	Correction limitation	[K]	OUT_PAR_09_XXX.X
56	Control parameter XpF	[-]	OUT_PAR_10_XX.X
60	Control parameter Prop_E	[K]	OUT_PAR_15_XXX

Table 12: Control

ID	Function	Unit	Command
58	Set point offset	[K]	OUT_PAR_14_XXX.X
66	Control in control variable X: 0 = internal / 1 = external Pt / 2 = external analog / 3 = external serial / 5 = external Ethernet / 6 = external EtherCAT / 7 = external Pt second (only on Integral)	[-]	OUT_MODE_01_X
68	Offset source X for set point: 0 = normal / 1 = external Pt / 2 = external analog / 3 = external serial / 5 = external Ethernet / 6 = external EtherCAT / 7 = external Pt second	[-]	OUT_MODE_04_X

**Comment (ID 66 and 68):** If X=3, the commands ID 66 and ID 68 cannot be executed in some constant temperature control devices until an external temperature specification has been received (via the command ID 15). Also notice that the command OUT\_PV\_05\_XXX.XX must be cyclically transmitted by the selected interface.

Table 13: Rights

ID	Function	Unit	Command
62	Keyboard master (equivalent to "KEY"): 0 = unlock / 1 = lock	[-]	OUT_MODE_00_X
64	Keyboard remote control unit (command): 0 = unlock / 1 = lock	[-]	OUT_MODE_03_X

Table 14: Status

ID	Function	Unit	Command
74	Switch the device on/off (standby)	[-]	START/STOP

Table 15: Programmer

ID	Function	Unit	Command
76	Select the program for the subsequent commands (X = 1 – 5). The default program is 5 when the constant temperature equipment is switched on.	[-]	RMP_SELECT_X
78	Start programmer	[-]	RMP_START
79	Pause programmer	[-]	RMP_PAUSE
80	Continue programmer (after pause)	[-]	RMP_CONT
81	End programmer	[-]	RMP_STOP

Note the following instructions:

- " " (blank space) can also be used for "\_".
- Response from thermostat will be "OK" or, if there is an error, "ERR\_X". RS 485 interface for example "A015\_OK" or if there is an error "A015\_ERR\_X".
- The command from the control station must be made with a CR, CRLF or LF CR.
- The response from the constant temperature equipment is always made with a CRLF.
- After each command is sent to the constant temperature equipment, it is necessary to wait for the reply before sending another command. This ensures that the sequencing of inquiries and answers is clear.  
CR = Carriage Return (Hex: 0D); LF = Line Feed (Hex: 0A)

#### Acceptable data formats

-XXXX.XX	-XXXX.X	-XXXX.	-XXXX	XXXX.XX	XXXX.X	XXXX.	XXXX
-XXX.XX	-XXX.X	-XXX.	-XXX	XXX.XX	XXX.X	XXX.	XXX
-XX.XX	-XX.X	-XX.	-XX	XX.XX	XX.X	XX.	XX
-X.XX	-X.X	-X.	-X	X.XX	X.X	X.	X
-.XX	-.X	.XX	.X				

#### 4.5.2 Read commands of the interface

Valid for the Ethernet interface and for the RS 232/485 interface module

A read error is a query for current data sent to the constant temperature equipment by the control station.

Table 16: Temperature

ID	Function	Unit, resolution	Command
2	Temperature set point	[°C]	IN_SP_00
3	Bath temperature (outflow temperature)	[°C], 0.01°C	IN_PV_00
4	Bath temperature (outflow temperature)	[°C], 0.001°C	IN_PV_10
5	Query of the controlled temperature (internal/external Pt/external analog/external serial)	[°C]	IN_PV_01
7	External temperature $T_E$ (Pt)	[°C]	IN_PV_03
8	External temperature $T_E$ (analog input)	[°C]	IN_PV_04
14	External temperature $T_E$ (Pt)	[°C], 0.001°C	IN_PV_13
25	Overtemperature turn off point $T_{Max}$	[°C]	IN_SP_03
27	Limitation of outflow temperature $T_{iH}$ (upper limit)	[°C]	IN_SP_04
29	Limitation of outflow temperature $T_{iH}$ (lower limit)	[°C]	IN_SP_05
33	Set temperature $T_{set}$ in Safety Mode (safe set point in case of communication interruption).	[°C]	IN_SP_07

Table 17: Pump

ID	Function	Unit	Command
12	Flow rate Flow controller must be connected	[l/min]	IN_PV_07
18	Pump power stage	[-]	IN_SP_01

Table 18: Fill level

ID	Function	Unit	Command
9	Bath level (fill level)	[-]	IN_PV_05

Table 19: Actuating signal

ID	Function	Unit	Command
11	Resolution of controller actuating signal in per mill [0.1%] – negative value → device is cooling – positive value → device is heating	[‰]	IN_PV_06

Table 20: Cooling

ID	Function	Unit	Command
24	Cooling mode: 0 = Off / 1 = On / 2 = Automatic	[-]	IN_SP_02

Table 21: Safety

ID	Function	Unit	Command
35	Timeout communication via interface (1 - 99 seconds; 0 = Off)	[s]	IN_SP_08
73	Status of Safety Mode: 0 = off (inactive) / 1 = on (active)	[-]	IN_MODE_06

Table 22: Control parameters

ID	Function	Unit	Command
39	Control parameter Xp	[-]	IN_PAR_00
41	Control parameter Tn (181 = Off)	[s]	IN_PAR_01
43	Control parameter Tv	[s]	IN_PAR_02
45	Control parameter Td	[s]	IN_PAR_03
47	Control parameter KpE	[-]	IN_PAR_04
49	Control parameter TnE	[s]	IN_PAR_05
51	Control parameter TvE	[s]	IN_PAR_06
53	Control parameter TdE	[s]	IN_PAR_07
55	Correction limitation	[K]	IN_PAR_09
57	Control parameter XpF	[-]	IN_PAR_10
61	Control parameter Prop_E	[K]	IN_PAR_15

Table 23: Control

ID	Function	Unit	Command
59	Set point offset	[K]	IN_PAR_14
67	Control in control variable X: 0 = internal / 1 = external Pt / 2 = external analog / 3 = external serial / 5 = external Ethernet / 6 = external EtherCAT / 7 = external Pt second (only on Integral)	[-]	IN_MODE_01
69	Offset source X for set point: 0 = normal / 1 = external Pt / 2 = external analog / 3 = external serial / 5 = external Ethernet / 6 = external EtherCAT / 7 = external Pt second (only on Integral)	[-]	IN_MODE_04

Table 24: Rights

ID	Function	Unit	Command
63	Status of Base remote control keyboard: 0 = free / 1 = blocked	[-]	IN_MODE_00
65	Status of remote control keyboard: 0 = free / 1 = blocked	[-]	IN_MODE_03

Table 25: Status

ID	Function	Unit	Command
75	Standby status: 0 = Device is switched on / 1 = Device is switched off	[-]	IN_MODE_02
107	Device type (Example answer: "PRO")	[-]	TYPE
130	Device status: 0 = OK / -1 = Fault	[-]	STATUS
131	<p>Fault diagnosis; a 7-digit answer in the format XXXXXXXX is output, whereby each digit X contains fault information (0 = no fault / 1 = fault).</p> <p>The following information is defined for the seven places of the answer format:</p> <ul style="list-style-type: none"> <li>■ 1. Character = error</li> <li>■ 2. Character = alarm</li> <li>■ 3. Character = warning</li> <li>■ 4. Character = overtemperature</li> <li>■ 5. Character = sublevel</li> <li>■ 6. Character = higher level (alarm setting)</li> <li>■ 7. Character = external control value missing</li> </ul>	[-]	STAT

Table 26: Programmer

ID	Function	Unit	Command
77	Program used as a basis for further commands	[-]	RMP_IN_04
88	Current segment number	[-]	RMP_IN_01
90	Number of preset program sequences	[-]	RMP_IN_02



ID	Function	Unit	Command
92	Current program loop	[-]	RMP_IN_03
94	Currently running program (0 = no program currently running)	[-]	RMP_IN_05

Table 27: Contact input/output

ID	Function	Unit	Command
96	Contact input 1: 0 = open / 1 = closed Contact module must be present	[-]	IN_DI_01
98	Contact input 2: 0 = open / 1 = closed	[-]	IN_DI_02
100	Contact input 3: 0 = open / 1 = closed	[-]	IN_DI_03
102	Contact output 1: 0 = open / 1 = closed Contact module must be present	[-]	IN_DO_01
104	Contact output 2: 0 = open / 1 = closed	[-]	IN_DO_02
106	Contact output 3: 0 = open / 1 = closed	[-]	IN_DO_03

Table 28: SW version

ID	Function	Unit	Command
108	Control system	[-]	VERSION_R
109	Protection system	[-]	VERSION_S
110	Remote control (Command) (remote control unit must be present)	[-]	VERSION_B
111	Cooling system (only for devices with active cooling)	[-]	VERSION_T
112	Analog interface module (interface module must be present)	[-]	VERSION_A
114	RS 232/485 interface module or Profibus / Profinet (interface module must be present)	[-]	VERSION_V
116	EtherCAT interface module (interface module must be present)	[-]	VERSION_Z
117	Contact interface module (interface module must be present)	[-]	VERSION_D
118	Solenoid valve for cooling water (solenoid valve must be present)	[-]	VERSION_M_0
119	Solenoid valve for automatic filling device (solenoid valve must be present)	[-]	VERSION_M_1
120	Solenoid valve for constant level device (Solenoid valve must be present)	[-]	VERSION_M_2
121	Solenoid valve, shut off valve 1 (Solenoid valve must be present)	[-]	VERSION_M_3

ID	Function	Unit	Command
122	Solenoid valve, shut off valve 2 (Solenoid valve must be present)	[-]	VERSION_M_4
128	External Pt100 interface 0 (module must be present)	[-]	VERSION_E

Note the following instructions:

- " " (blank space) can also be used for "\_".
- If not otherwise specified in the command, the response will always be given in fixed point format "XXX.XX" or for negative values "-XXX.XX" or "ERR\_X". (RS 485 interface e.g. "A015\_XXX.XX" or "A015\_ERR\_X").
- The command from the control station must be made with a CR, CRLF or LFCR.
- The response from the constant temperature equipment is always made with a CRLF.
- After each command is sent to the constant temperature equipment, it is necessary to wait for the reply before sending another command. This ensures that the sequencing of inquiries and answers is clear.  
CR = Carriage Return (Hex: 0D); LF = Line Feed (Hex: 0A)

#### 4.5.3 Error messages from the constant temperature equipment to the control station

Error messages are described in this list.

Error	Description
ERR_2	Wrong entry (for example, buffer overflow).
ERR_3	Wrong command
ERR_5	Syntax error in value
ERR_6	Impermissible value
ERR_8	Module or value not available.
ERR_30	All segments in the programmer are occupied.
ERR_31	Not possible to specify set point value, analog set point input set to ON.
ERR_33	An external temperature probe is missing.
ERR_34	Analog value not present.
ERR_35	Safety Mode cannot be started because the Safety Mode function has not been activated.
ERR_36	Not possible to specify set point value, programmer is running or has been paused.
ERR_37	Impossible to start the programmer, analog set point value input is turned on.
ERR_38	Not possible to activate from Safety Mode.

## 4.6 Setting up the circulation thermostat



**CAUTION!**  
Risk of heat transfer liquid escaping from incorrectly sealed pump connections

Slipping hazard, loss of heat transfer liquid

- Attach a stopper or pump link to the pump connections if there is no external consuming unit connected.

## 4.7 Racks, platforms, rising platforms

This section is relevant for:

- the Bath thermostat device category

Chemical samples, for example, are placed on special racks, platforms and rising platforms for temperature control purposes.



**NOTICE!**  
Risk of bath vessel corroding due to different electrochemical potentials from metal rack and bath

Device damage

- If the stainless steel vessel makes direct contact with a rack, it may result in electrochemical oxidation. Avoid using racks that may react in this way to direct contact with the vessel. Use LAUDA stainless steel racks or commercially available racks made from temperature-resistant plastic.

## 4.8 External consuming unit

### 4.8.1 Hoses

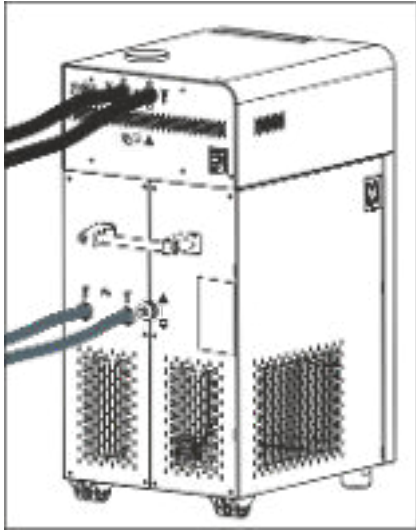

Fig. 22: Connected hoses



**CAUTION!**  
Risk of external hydraulic circuit bursting

Scalding, cold burns

- Use hoses with a greater compressive strength than the maximum possible pump pressure.



**CAUTION!**  
Risk of heat transfer liquid escaping

Scalding, cold burns

- The temperature and media resistance of the hoses used for the device overflow must be suitable for the application.



**CAUTION!**  
Risk of heat transfer liquid escaping due to the use of unsuitable hoses

Scalding, cold burns

- The temperature and media resistance of the hoses must be suitable for the application.



**CAUTION!**  
Contact with hot or cold hoses

Hot and cold burns

- Use insulated hoses for temperatures below 0 °C and above 70 °C.

Please also note the following:

- When laying the water cooling and heat transfer liquid hoses, make sure that the hoses cannot be kinked or crushed.

### Approved elastomer hoses

Hose type	Clear Ø in mm	Outer diameter in mm	Temperature range of the hose in °C	Application area	Catalog number
EPDM hose, uninsulated	9	13	10 – 90	for all LAUDA heat transfer liquids except mineral oils	RKJ 111
EPDM hose, uninsulated	12	16	10 – 90	for all LAUDA heat transfer liquids except mineral oils	RKJ 112

Hose type	Clear Ø in mm	Outer diameter in mm	Temperature range of the hose in °C	Application area	Catalog number
EPDM hose, insulated	12	35	-35 – 90	for all LAUDA heat transfer liquids except mineral oils	LZS 021
Silicone tube, uninsulated	11	15	10 – 100	Water, glycol/water mixture	RKJ 059
Silicone tube, insulated	11	33	-60 – 100	Water, glycol/water mixture	LZS 007



Heat transfer liquids approved for the device can be found in Chapter 5.1 “LAUDA heat transfer liquids” on page 58.

### Approved metal hoses

The following approved metal hoses with M16 x 1 cap nuts are manufactured from stainless steel. The clear opening measures 10 mm.

Hose type	Length in cm	Temperature range of the hose in °C	Application area	Catalog number
MC 50	50	10 – 400	With single insulation, suitable for all LAUDA heat transfer liquids	LZM 040
MC 100	100	10 – 400	With single insulation, suitable for all LAUDA heat transfer liquids	LZM 041
MC 150	150	10 – 400	With single insulation, suitable for all LAUDA heat transfer liquids	LZM 042
MC 200	200	10 – 400	With single insulation, suitable for all LAUDA heat transfer liquids	LZM 043
Pump short-circuit	18	10 – 400	With single insulation, suitable for all LAUDA heat transfer liquids	LZM 044
MK 50	50	-90 – 150	With foam insulation for the refrigeration sector, suitable for all LAUDA heat transfer liquids	LZM 052
MK 100	100	-90 – 150	With foam insulation for the refrigeration sector, suitable for all LAUDA heat transfer liquids	LZM 053
MK 150	150	-90 – 150	With foam insulation for the refrigeration sector, suitable for all LAUDA heat transfer liquids	LZM 054
MK 200	200	-90 – 150	With foam insulation for the refrigeration sector, suitable for all LAUDA heat transfer liquids	LZM 055
Pump short-circuit	18	-90 – 150	With foam insulation for the refrigeration sector, suitable for all LAUDA heat transfer liquids	LZM 045

## 4.8.2 Connecting an external consuming unit



**DANGER!**  
Risk of hot heat transfer liquid overflowing

Fire

- A connecting hose with a collecting vessel must be attached to the overflow.
- The collecting vessel and connecting hose must be designed to withstand the maximum temperature of the heat transfer liquid.
- Avoid ignition sources in the vicinity of the collecting vessel.



**WARNING!**  
Degradation of overflow or drain

Electric shock

- Overflow hose and drainage hose must each slope downward separately all the way into a collecting vessel.



**CAUTION!**  
Risk of external hydraulic circuit bursting from overpressure

Scalding, cold burns

- When laying the hoses, make sure they cannot kink.
- Use safety valves in the hydraulic circuit.



**CAUTION!**  
Risk of heat transfer liquid escaping during operation due to open consuming unit

Scalding, cold burns

- Always use hydraulically sealed consuming units.



**CAUTION!**  
Risk of heat transfer liquid escaping from consuming unit in an elevated location

Electric shock

- If the external consuming unit is positioned above the device, heat transfer liquid may escape from the device when the pump stops. Therefore use the return protection available as an accessory in the external hydraulic circuit.



**CAUTION!**

Risk of heat transfer liquid escaping from consuming units in a higher or lower location

Electric shock

- If the external consuming unit is positioned above or below the device, heat transfer liquid may escape from the device or consuming unit when the pump stops. Therefore use the constant level device available as an accessory in the external hydraulic circuit.



**CAUTION!**

Risk of external consuming unit bursting

Scalding, cold burns

- If the external consuming unit is located in a lower position and is sensitive to pressure, also take into account the additional pressure resulting from the difference in height between the consuming unit and the device.

Please also note the following:

- Always use the largest possible diameters and shortest possible hose lengths in the external circuit.  
If the hose diameter is too narrow, the insufficient flow rate will cause a drop in temperature between the device and the external consuming unit. In this case, increase the bath temperature or pump level accordingly.
- Secure the hoses using hose clips.

## 4.9 Cooling water

### 4.9.1 Cooling water requirements



**NOTICE!**

Risk of cooling circuit leaking due to corrosion

Device damage

- Do not use corrosive cooling water.

The following safety notice is relevant for devices containing natural refrigerant:



**CAUTION!**  
Risk of cooling circuit leaking due to corrosion

Fire, explosion

- Do not use corrosive cooling water.

## Requirements

Cooling water is subject to specific purity requirements. A suitable procedure must be employed to purify the cooling water in line with the contamination in the water and maintain the water quality. Unsuitable cooling water may cause the condenser and the entire cooling water circuit to become blocked or damaged, or start to leak. The entire cooling circuit and cooling water circuit may sustain extensive consequential damage as a result.

- Free chlorine consisting of disinfectant, for example, and water containing chloride will cause pitting corrosion in the cooling water circuit.
- Distilled, deionized and demineralized water are unsuitable due to their reactivity and will cause corrosion in the cooling water circuit.
- Sea water is unsuitable due to its corrosive properties and will cause corrosion in the cooling water circuit.
- Iron particles and water containing iron will cause corrosion in the cooling water circuit.
- Hard water is unsuitable for cooling due to the high lime content and will lead to calcification of the cooling water circuit.
- Cooling water containing suspended matter is unsuitable.
- Untreated, unpurified water such as river water or cooling tower water is unsuitable due to its microbiological content (bacteria), which can settle inside the cooling water circuit.

## Suitable cooling water quality

Data	Value	Unit
pH value	7.5 – 9.0	---
Hydrocarbonate [HCO <sub>3</sub> <sup>-</sup> ]	70 – 300	mg/L
Chloride	< 50	mg/L
Sulfate [SO <sub>4</sub> <sup>2-</sup> ]	< 70	mg/L
Ratio hydrogen carbonate [HCO <sub>3</sub> <sup>-</sup> ] / sulfate [SO <sub>4</sub> <sup>2-</sup> ]	> 1	---
Total water hardness	4.0 – 8.5	°dH
Electrical conductivity	30 – 500	µS/cm
Sulfite (SO <sub>3</sub> <sup>2-</sup> )	< 1	mg/L
Free chlorine gas (Cl <sub>2</sub> )	< 0.5	mg/L
Nitrate (NO <sub>3</sub> <sup>-</sup> )	< 100	mg/L
Ammonia (NH <sub>3</sub> )	Not permitted	---
Iron (Fe), dissolved	< 0.2	mg/L



Data	Value	Unit
Manganese (Mn), dissolved	< 0.05	mg/L
Aluminum (Al), dissolved	< 0.2	mg/L
Free aggressive carbon dioxide (CO <sub>2</sub> )	Not permitted	---
Hydrogen sulfide (H <sub>2</sub> S)	Not permitted	---
Algae growth	Not permitted	---
Suspended matter	Not permitted	---

## 4.9.2 Connecting the cooling water

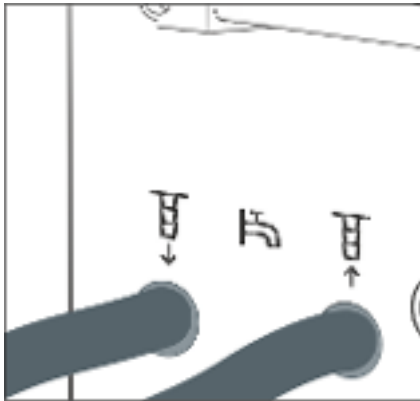

Fig. 23: Cooling water input and output

This section is relevant for:

- Devices with refrigerating machine
- Devices with cooling coil



Refer to ↗ Chapter 11.2 “Cooling capacity and cooling water” on page 116 for further information about the cooling water pressure, cooling water temperature and diameter of the cooling water hoses.

Please note:

- Connect the cooling water inlet and outlet according to the labeling on the device. The inlet and outlet of the cooling water supply may not be interchanged.
- The hoses used for the cooling water circuit must be suitable for the temperature range specified. Also observe the permitted hose diameter.
- Secure the hose nozzles or the coupling connectors to the hoses using hose clips.
- Secure the water cooling return hose in the outlet area to prevent the hose from jerking suddenly, even when pressure surges occur. Secure the water cooling return hose in the outlet area in such a way that hot cooling water cannot spray out.
- Avoid kinking or crushing the hoses.
- We recommend using a leakage water detector with water shut-off function to prevent leakages from causing damage in the cooling water system.
- Only use cooling water that meets the quality requirements.
- If the condenser leaks, there is a danger that refrigerating machine oil or combustible/non-combustible refrigerant from the device’s refrigerant circuit will mix with the cooling water. Observe the legal requirements and provisions of the water supply company applicable at the operation site.

## 5 Commissioning

### 5.1 LAUDA heat transfer liquids



**DANGER!**  
Use of unsuitable heat transfer liquid

Fire

- Select a heat transfer liquid with a temperature range suitable for the application.

Please note:

- If the heat transfer liquid reaches the lower limit of the temperature range, the temperature control properties can be expected to deteriorate as a result of the increase in viscosity. Therefore, only fully utilize this temperature range when absolutely necessary.
- Never use contaminated heat transfer liquids. Contamination in the pump housing can cause the pump to seize and the device to shut down.
- Observe the safety data sheet for the heat transfer liquid. You can request a copy of the safety data sheets at any time, if necessary.

Table 29: Permitted heat transfer liquids

Designation	Chemical name	Working temperature range in °C	Viscosity (kin) in mm <sup>2</sup> /s (at 20 °C)	Viscosity (kin) in mm <sup>2</sup> /s at temperature	Flash point in °C
Kryo 95	Silicone oil	-95 – 60	1.6	20 at -80 °C	64
Kryo 60	Silicone oil	-60 – 60	3	25 at -60 °C	62
Kryo 51	Silicone oil	-50 – 120	5	34 at -50 °C	120
Kryo 30	Monoethylene glycol/ water mixture	-30 – 90	4	50 at -25 °C	---
Kryo 20	Silicone oil	-20 – 170	11	28 at -20 °C	170
Aqua 90	Decalcified water	5 – 90	1	---	---
Ultra 301 <sup>Ⓟ</sup>	Mineral oil	40 – 230	76.5	35.4 at 40 °C	245
Therm 250	Silicone oil	50 – 250	125	25 at 70 °C	300
Therm 180	Silicone oil	0 – 180	23	36 at 0 °C	250
Therm 160	Polyalkylene glycol and additives	60 – 160	141	28 at 60 °C	260

<sup>Ⓟ</sup>Recommendation: Overlay with nitrogen at 150 °C and above

Table 30: Heat transfer liquid order numbers

Designation	Container size		
	Catalog number		
	5 L	10 L	20 L
Kryo 95	LZB 130	LZB 230	LZB 330
Kryo 60	LZB 102	LZB 202	LZB 302
Kryo 51	LZB 121	LZB 221	LZB 321
Kryo 30	LZB 109	LZB 209	LZB 309
Kryo 20	LZB 116	LZB 216	LZB 316
Aqua 90	LZB 120	LZB 220	LZB 320
Ultra 301	LZB 153	LZB 253	LZB 353
Therm 250	LZB 122	LZB 222	LZB 322
Therm 180	LZB 114	LZB 214	LZB 314
Therm 160	LZB 106	LZB 206	LZB 306

- When using Kryo 30:  
The water content decreases during longer periods of operation at higher temperatures and the mixture becomes combustible (flash point 119 °C). Check the mixing ratio using a hydrometer.
- When using Aqua 90:  
Evaporation losses occur at higher temperatures. In this case, use a bath cover.
- Never use silicone oil in silicone tubes.
- When using mineral oils:  
Do not use in combination with an EPDM hose.

#### Heat transfer liquid, water

- The proportion of alkaline earth ions in the water must be between 0.71 mmol/L and 1.42 mmol/L (equivalent of 4.0 °dH and 8.0 °dH). Harder water leaves limescale deposits in the device.
- The pH value of the water must be between 6.0 and 8.5.
- Distilled, deionized and demineralized water are unsuitable due to their reactivity. High-purity water and distillates are suitable as a heat transfer liquid after 0.1 g of soda ( $\text{Na}_2\text{CO}_3$ , sodium carbonate) is added for every liter of water.
- Sea water is unsuitable due to its corrosive properties.
- Avoid chlorine content in the water at all costs. Do not add chlorine to the water. Cleaning agents and disinfectants, for example, contain chlorine.
- The water must be free of impurities. Water with iron content is unsuitable due to rust formation and untreated river water is unsuitable due to algae growth.
- The addition of ammonia is not permitted.

## 5.2 Filling the device

LAUDA is not liable for damages resulting from the use of unsuitable heat transfer liquids. Approved heat transfer liquids → Chapter 5.1 “LAUDA heat transfer liquids” on page 58.



**DANGER!**  
Risk of hot heat transfer liquid overflowing

Fire

- A connecting hose with a collecting vessel must be attached to the overflow.
- The collecting vessel and connecting hose must be designed to withstand the maximum temperature of the heat transfer liquid.
- Avoid ignition sources in the vicinity of the collecting vessel.



**WARNING!**  
Splashing heat transfer liquid

Eye damage

- Always wear suitable safety glasses when working on the device.



**WARNING!**  
Overflow of heat transfer liquid

Electric shock

- Do not overfill the device. Observe the level display and the thermal volume expansion of the heat transfer liquid.



**WARNING!**  
Spraying of heat transfer liquid

Electric shock

- Avoid spraying heat transfer liquid.



**WARNING!**  
Overflow of heat transfer liquid caused by objects placed in the bath

Scalding, cold burns

- When filling, take into account any objects placed in the bath.



**WARNING!**  
Overflow of heat transfer liquid due to increase in volume caused by heating

Scalding, electric shock

- Take into account the increase in volume caused by heating of the heat transfer liquid.



**CAUTION!**  
Risk of heat transfer liquid escaping

Slipping hazard

- Draining tap must be closed.



*Heat transfer liquids expand when heated (approx. 10 % for every 100 °C). If an external consuming unit is connected, expansion occurs exclusively in the thermostat bath.*

## Bath thermostat



Fig. 24: Filling the bath thermostat

1. Close the draining tap by by turning it clockwise.
2. Carefully fill the bath with heat transfer liquid.



*The recommended fill level in the bath thermostat is between 30 and 100 mm below the upper edge of the bath.*

Overlevel handling is initiated at a fill level of 25 mm below the upper edge of the bath. The customer can adjust overlevel handling as required. A *low level warning* is issued at approx. 110 mm and a *low level alarm is triggered* at approx. 120 mm below the upper edge of the bath.

## Circulation thermostat

The device has a filling mode for convenient filling of the heat transfer liquid.

Filling mode helps you fill the device.

1. Close the draining tap by by turning it clockwise.
2. Attach a suitable hose (heat transfer liquid/temperature) to the overflow connection on the device.
3. Place the end of this hose into a suitable canister to collect the overflowing heat transfer liquid.

- Switch on the device.



*If filling mode is active, the symbol for the bath vessel will be flashing in the home window. The device does not heat or cool.*

- ▶ If the device is empty, *filling mode* is activated immediately after the device is switched on.  
If the device is not empty, *filling mode* can be manually started. Select the *Settings* → *Filling mode* → *Start filling* menu item.

- Remove the tank lid.

- ▶ A screen is fitted to the filling nozzle. Do not remove the screen!

- Carefully fill with heat transfer liquid.



*The quantity per level is approximately 0.15 liters. With a quantity of 2.4 liters or more in the bath vessel, level 1 is displayed.*

- ▶ A signal tone with long intervals is emitted starting from around the fifth level to warn against overfilling the device. If you continue filling, the interval of the signal is shortened.  
If a continuous tone sounds, the bath vessel is full. If you continue filling the device, it will overflow.

- If the fill level (starting at level 5) is adequate, press the [Standby] softkey to start the pump and fill the connected external consuming unit.

- ▶ Heat transfer liquid is pumped into the external consuming unit. The level of the heat transfer liquid in the bath vessel drops.

- Replenish the heat transfer liquid.

- ▶ If, however, the fill level drops too far, the device automatically switches to the "Low level" alarm state. The pump is switched off.

- Add sufficient heat transfer liquid. Deactivate the alarm using the [Unlock key]. The pump automatically restarts.

- Carry out steps 8 and 9 until the device and the connected consuming unit are filled.

- Press [Stop filling] to exit from filling mode and deactivate the acoustic alerts.

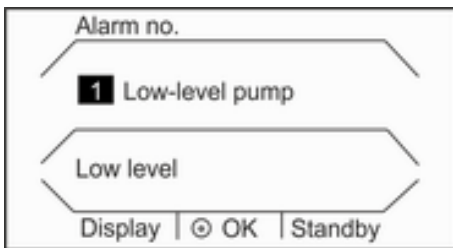

Fig. 25: Low Level Alarm



*The [filling mode] can be used to refill the device during operation.*



*If [Fill mode] is active, the device does not heat or cool. You can only start the device after you end [Fill mode].*



**DANGER!**  
Risk of hot heat transfer liquid escaping

Fire

- Degas slowly and carefully. Avoid ignition sources in the vicinity of the filling nozzle and overflow.



**DANGER!**  
Hot heat transfer liquid in the expansion vessel

Fire

- Keep the cover of the expansion vessel closed during operation.

### 5.3 Changing/draining heat transfer liquid



**WARNING!**  
Contact with hot or cold heat transfer liquid

Scalding, cold burns

- Bring the heat transfer liquid to room temperature before draining.



**WARNING!**  
Splashing heat transfer liquid

Eye damage

- Always wear suitable safety glasses when working on the device.



*Observe the regulations for the disposal of used heat transfer liquid.*

1. Allow the device and heat transfer liquid to cool or warm up to room temperature.
2. Turn off the device and pull out the mains plug.
3. Attach a hose to the drain nozzle.
4. Place the hose in a suitable container to collect the heat transfer liquid.



*It may be necessary to drain the device several times if the filling volume is high.*



Fig. 26: Attaching hose

5. Open the drain tap by turning it counterclockwise.



*Drain the bath, external consuming unit, accessories and hoses completely.*

6. If necessary, clean or flush out the device (with new heat transfer liquid, for example).



*After changing to a different heat transfer liquid, you may have to set new values for the temperature limit, overtemperature switch-off point and/or the controller output limit.*

## 5.4 Establishing a mains connection



**WARNING!**  
Contact with voltage conductors due to faulty mains cable

Electric shock

- The mains cable must not come into contact with the top of the device, hoses containing hot heat transfer liquid and other hot parts, neither during operation nor after the device is switched off.



**NOTICE!**  
Use of impermissible mains voltage or mains frequency

Device damage

- Compare the type plate with the available mains voltage and mains frequency.

Please note the following:

- Note for electric installation on site:
  - The devices must be protected with a 16 ampere circuit breaker fitted during installation.  
Exception: Devices with 13 ampere UK plugs.
- Only use the supplied power cable for the power supply.
- Only connect the device to sockets with a protective earth conductor (PE).



## 5.5 Switching on the device



### WARNING!

Risk of contact with cold/warm parts if the operator does not realize that the device is switched on.

Scalding, cold burns

- The remote control unit must be kept within visual range of the device.

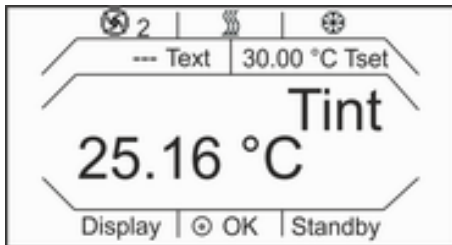

Fig. 27: Home window

1. Switch on the device at the mains switch.
  - ▶ A signal tone is emitted and the operation and fault indicator LED lights up several times.  
The LED then lights up green continuously when there are no faults pending.
2. The version numbers of the installed software appear on the display for about 5 seconds.  
Then the home window appears.
3. The device can now be operated using the Base remote control unit.



You can now view the version numbers of the software installed on the device in the menu at any time.

## 5.6 Display buttons

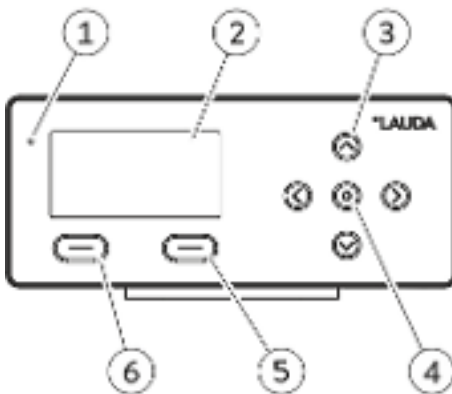

Fig. 28: Base remote control unit

- 1 Brightness sensor
- 2 Display
- 3 Four cursor buttons
- 4 Enter key
- 5 Right softkey (standby)
- 6 Left softkey (display/ESC)

The display buttons control the functions on the device.

- The up, down, right and left cursor buttons are used to navigate in the display.
- The input button is used to confirm a selection in the display or execute a command.
- The softkeys are used to execute the functions indicated on the display that are assigned to these buttons.

### Key lock

The keys on the Base remote control can be locked to prevent accidental changes.

### Activating

The Base remote control displays the home window.

1. Press and hold down the [input button].
2. Press and hold down the [Down] cursor button.
  - ▶ After 5 seconds, the key lock is activated.  
Only the left [Display] softkey continues working.

## Deactivating

1. Press and hold down the [input button].
2. Press and hold down the [Up] cursor button.
  - ▶ After 5 seconds, the key lock is deactivated.

## 5.7 Base remote control unit menu structure

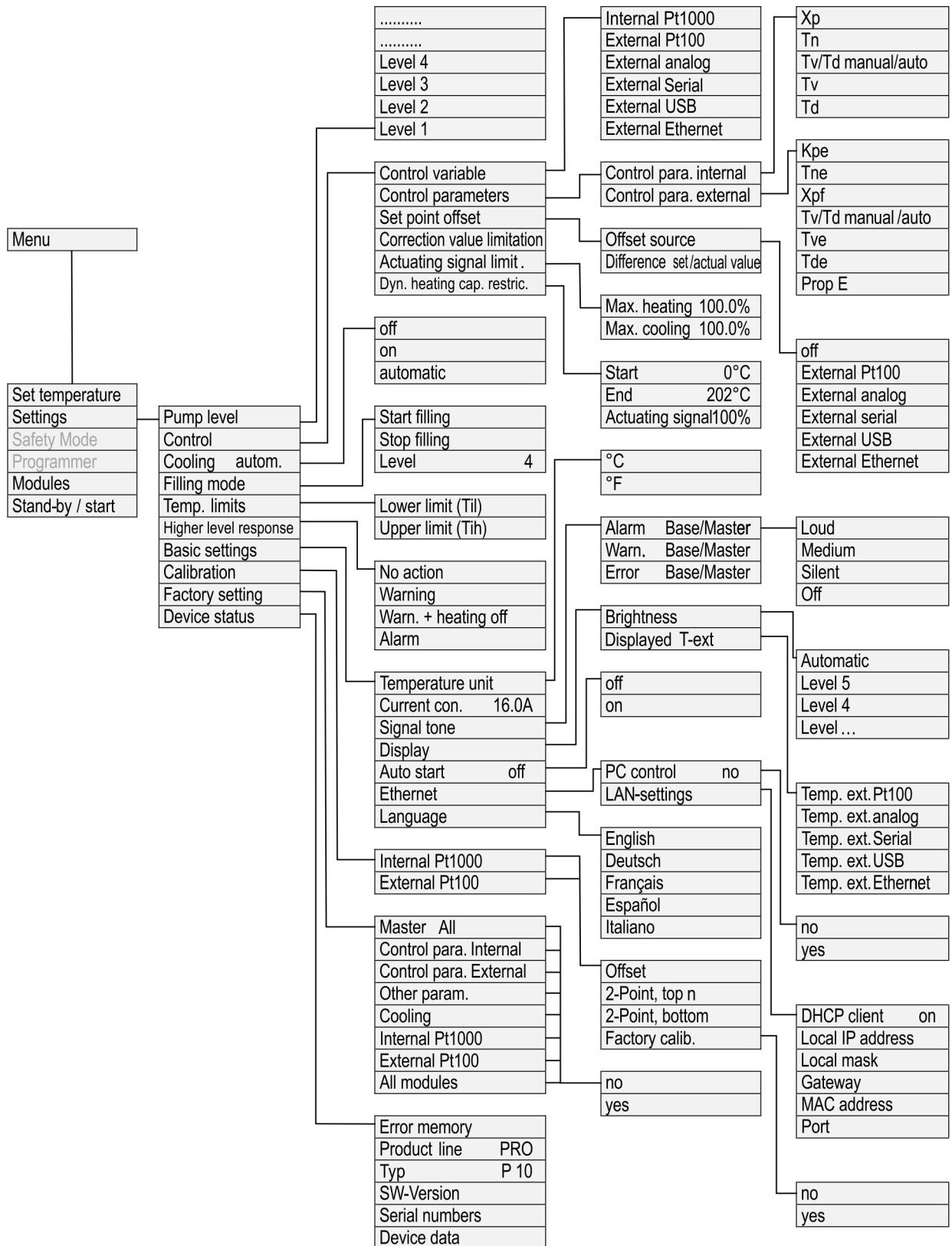

Fig. 29: Base menu, Part 1

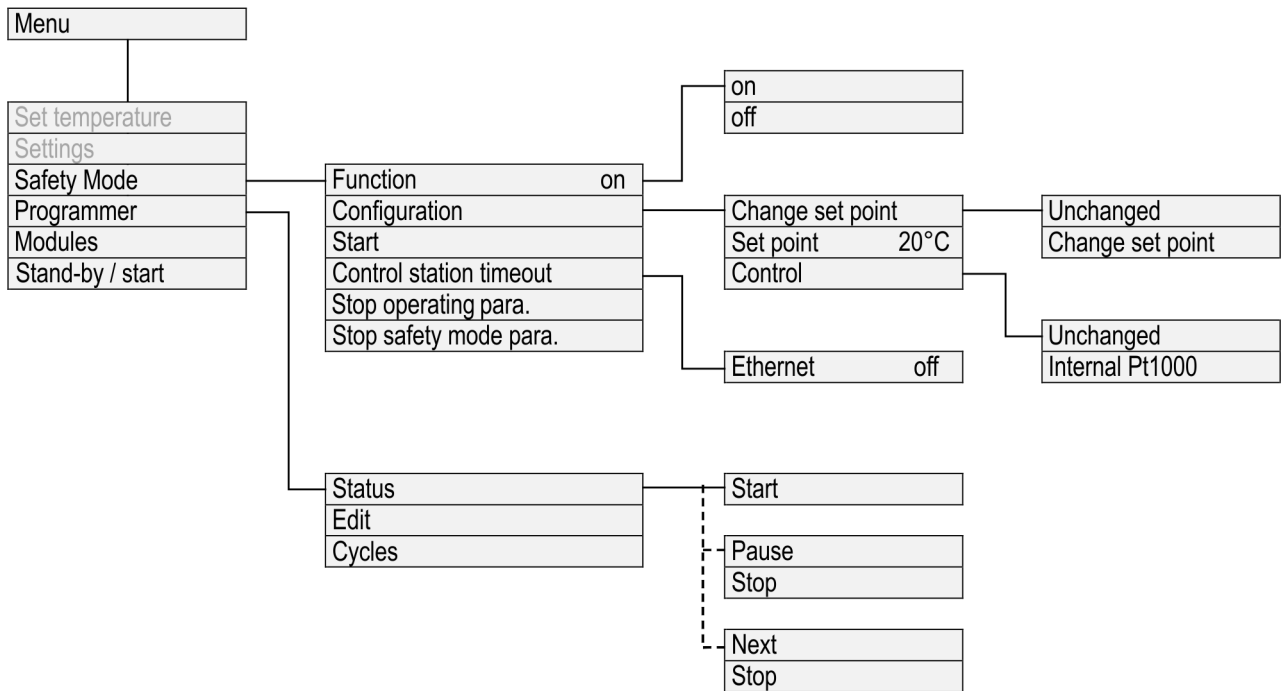

Fig. 30: Base menu, Part 2

Functions that cannot be executed are omitted from the menu structure.

### 5.8 Setting overtemperature protection Tmax



**WARNING!**  
Risk of heat transfer liquid overheating due to incorrect entry of overtemperature switch-off point Tmax

Fire

- Set the overtemperature switch-off point to 5 K above the upper limit of the temperature range for your application. The overtemperature switch-off point must be below the flash point of the heat transfer liquid.

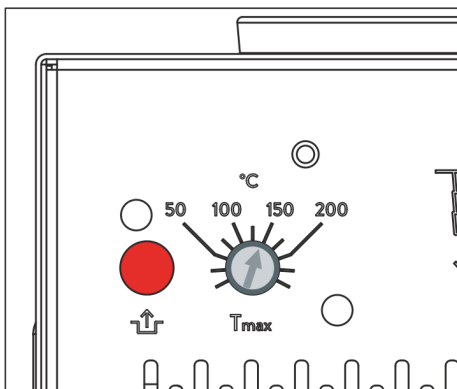

Fig. 31: Setting Tmax

The maximum temperature Tmax for the overtemperature protection is set at the rotary knob using a screwdriver. The exact preset maximum temperature also appears automatically on the display.



Chapter 7.7 “Checking the overtemperature protection” on page 101

This section is relevant for:

- Device operation using the Base remote control unit
1. Adjust the rotary knob using a screwdriver. Turn the knob counter-clockwise to decrease the  $T_{max}$  value.
    - ▶ The new preset maximum temperature  $T_{max}$  appears on the display.
 

The maximum temperature is adopted automatically, the  $T_{max}$  window is replaced by the home window after a few seconds.

## 5.9 Setting temperature limits $T_{ih}$ and $T_{il}$

This function is used to set temperature limits  $T_{ih}$  and  $T_{il}$ . The temperature limits restrict the temperature target value. A warning is issued if the internal actual temperature is outside the temperature limits. The temperature limits should reflect the limits of your application. A tolerance of 2 K should also be added to the upper and lower temperature limits to compensate for overshoots by the control, in particular external controls. The working temperature range of the heat transfer liquid must also be taken into consideration when defining temperature limits.

This section is relevant for:

- Device operation using the Base remote control unit

### Setting $T_{ih}$ and $T_{il}$

1. Press any button on the Base unit to display the Home window.
2. Press the [input button] to open the menu.
3. Select the *Settings* → *Temp. limit values* menu items using the cursor buttons.
  - ▶ Two options appear on the display.
4. Select one of the following options:
  - Select the entry [Lo. limit  $T_{il}$ ] to set the lower limit value.
  - Select the entry [Upper limit value  $T_{ih}$ ] to set the upper limit value.
5. Adjust the value in the input window using the cursor buttons.
6. Press [OK].
  - ▶ The value is adopted and the input window disappears.
7. Press the [ESC] softkey to open the home window.



Fig. 32: Setting the temperature limit

## 5.10 Setting the temperature target value $T_{set}$

The temperature target value  $T_{set}$  is the temperature that the constant temperature equipment should reach and then maintain.

This section is relevant for:

- Device operation using the Base remote control unit

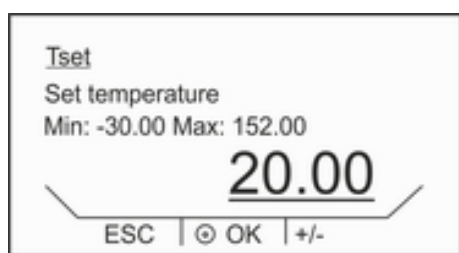

Fig. 33: Entering set temperature

1. Press any button on the Base unit to display the Home window.
2. Press the [input button] to open the menu.
3. Press the [input button] again to select the first [Set temperature] menu item.
  - ▶ An input window appears on the display.
4. Adjust the new set temperature using the cursor buttons.
5. Press [OK] to confirm the new value.
  - ▶ The value is accepted.
6. Press the [ESC] softkey to open the home window.

## 5.11 Basic settings

### 5.11.1 Safety Mode

#### Purpose of Safety Mode

Safety Mode gives users of LAUDA constant temperature equipment the option of defining a safe temperature state in advance. In the event of a malfunction or error, the user can manually switch to this state quickly and easily or allow the device to do so automatically.



When Safety Mode is **active**, the constant temperature equipment continues to operate at the set temperature  $T_{set}$  and control variable previously defined in the Safety Mode menu.

In the Safety Mode submenu, the user specifies how the device should respond (actions) if certain events occur.

Which events lead to the activation of Safety Mode?

- Being activated manually via the constant temperature equipment.
- Command via interface.
- Being triggered by certain alarms.
- Communication with the control station being interrupted.

What indicates that Safety Mode is active?

- A flashing Safety Mode icon  appears on the display when the device is operating. The pump impeller and pump level number are hidden. If the device is on standby,  $T_{ext}$  is hidden and the Safety Mode icon  is displayed instead.

What happens in active Safety Mode if there is **no alarm** pending?

- The *Safety Mode* window appears on the Base display and gives you the option of quitting *Safety Mode*.

What happens in active Safety Mode if **an alarm** is pending?

- The *Alarm* window appears in the Base display. The *Safety Mode* window only appears with the option of quitting *Safety Mode* once the alarm has been acknowledged on the device.
- Special case *Overtemperature*

#### Activating Safety Mode using an interface command

Safety Mode can be activated using an interface command. The device is then set to a safe state.

Table 31: List of interfaces and associated interface commands

Interface	Interface command	ID	Description
Ethernet interface	OUT_MODE_06_1	72	Interface command activates Safety Mode.
RS 232/485 interface	OUT_MODE_06_1	72	Interface command activates Safety Mode.

### Activating Safety Mode in the event of an alarm

The constant temperature equipment can also activate Safety Mode automatically in the event of an alarm.



*Safety Mode can only become active if the Safety Mode function was activated in the menu beforehand.*

Table 32: List of alarms that can be activated by Safety Mode

Alarm	Description of action
Alarm 9 External actual value Pt is not available	Safety Mode is activated. If the parameter transfer was activated in Safety Mode, the temperature set point should be adopted from the Safety Mode parameters. External control is switched automatically to internal control.
Alarm 10 External actual value Analog is not available	Safety Mode is activated. If the parameter transfer was activated in Safety Mode, the temperature set point should be adopted from the Safety Mode parameters. External control is switched automatically to internal control.
Alarm 11 External actual value Serial is not available	Safety Mode is activated. If the parameter transfer was activated in Safety Mode, the temperature set point should be adopted from the Safety Mode parameters. External control is switched automatically to internal control.
Alarm 12 Current interface 1, interruption	Safety Mode is activated. Safety Mode parameters are adopted depending on the configuration.
Alarm 13 Current interface 2, interruption	Safety Mode is activated. Safety Mode parameters are adopted depending on the configuration.
Alarm 15 Fault at the digital input	Safety Mode is activated. Safety Mode parameters are adopted depending on the configuration.
Alarm 16 Refilling has failed	Safety Mode is activated. Safety Mode parameters are adopted depending on the configuration.
Alarm 17 Set valve to inflow	Safety Mode is activated. Safety Mode parameters are adopted depending on the configuration.
Alarm 18 Set valve to outflow	Safety Mode is activated. Safety Mode parameters are adopted depending on the configuration.
Alarm 20 External actual value from Ethernet is not available	Safety Mode is activated. If the parameter transfer was activated in Safety Mode, the temperature set point should be adopted from the Safety Mode parameters. External control is switched automatically to internal control.

### Activating Safety Mode by disconnecting from the control station

Monitoring of the control station by the constant temperature equipment can be activated in the device menu. The control station must send a command to the constant temperature equipment periodically. The user must define the time the system waits before reporting a communication fault. If the control station fails to send a command within the specified time, the interface (Ethernet or RS 232) reports a communication fault. The constant temperature equipment then switches to Safety Mode and a warning is generated.



### Switch Safety Mode to standby

1. Press any button on the Base unit to display the Home window.
2. Press the [input button] to open the menu.
3. Select the *Safety Mode* menu item.

Table 33: Settings in the *Safety Mode* menu

Menu item	Description
Function	<p>Here you can define whether the Safety Mode function is on standby or deactivated.</p> <p>Select one of the following options:</p> <ul style="list-style-type: none"> <li>■ Option <i>On</i>: The Safety Mode function is on standby.</li> <li>■ Option <i>Off</i>: The Safety Mode function is deactivated.</li> </ul> <p>If the Safety Mode functions is deactivated,</p> <ul style="list-style-type: none"> <li>■ Safety Mode cannot be activated via the <i>Start</i> menu item.</li> <li>■ Activation by an alarm or interface is also blocked.</li> <li>■ Safety Mode parameters cannot be modified.</li> </ul>
Configuration	In this submenu, you can configure the parameters that the device uses when Safety Mode is active.
Start	Starts the Safety Mode function. The <i>Start</i> menu item only appears if Safety Mode was switched to standby with the option <i>On</i> in the <i>Function</i> submenu.
Control station timeout	The timeouts for the Ethernet and RS 232 interfaces are configured separately in this submenu (timeout 1 to 60 seconds, 0 = off).

Table 34: Settings in the *Configuration* menu

Description when Safety Mode is active	Configure the Safety Mode parameters
<i>Set point</i> : When Safety Mode is activated, the temperature of the device can be regulated to this stored value.	Enter the set point $T_{set}$ here.
<i>Change set point</i> : When Safety Mode is activated, the temperature of the device is regulated to the value stored in the Set point menu.	<p>Select one of the following options:</p> <ul style="list-style-type: none"> <li>■ Option <i>Unchanged</i>: The device retains the previous set point.</li> <li>■ Option <i>Change set point</i>: The temperature of the device is regulated to this stored set point <math>T_{set}</math>.</li> </ul>
<i>Control</i> : When Safety Mode is activated, the temperature of the device is regulated to this stored value.	<p>Select one of the following options:</p> <ul style="list-style-type: none"> <li>■ Option <i>Unchanged</i>: The device retains the previous control variable.</li> <li>■ Option <i>Internal Pt1000</i>: The device variable is regulated to the Internal Pt1000 control variable.</li> </ul>

### Deactivation of active Safety Mode

If Safety Mode is active, the operator can deactivate Safety Mode using the remote control.

Deactivating Safety Mode via an interface is not possible.

**i** *If an alarm has triggered Safety Mode, the alarm on the constant temperature equipment must be reset first. Only then can Safety Mode be deactivated.*

Menu for deactivating Safety Mode	Description
Operating parameters	Safety Mode is ended. The device continues operating with the parameters (Tst, control variable) preset before Safety Mode was activated.
Safety Mode parameters	Safety Mode is ended. The device continues operating with the parameters (Tset, control variable) preset in the Safety Mode configuration.

### 5.11.2 Adjusting the volume of signal tones

The device indicates alarms, warnings and errors both visually and acoustically.

In this menu, you can adjust the volume of the signal tones for: errors, alarms and warnings. The volume settings are: off, low, medium and loud.

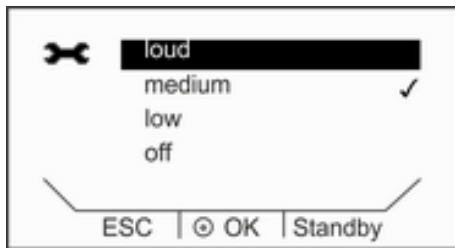

Fig. 34: Adjusting volume

1. Press any button on the Base unit to display the home window.
2. Press the [input button] to open the menu.
3. Select the *Settings* → *Basic setting* → *Signal tone* menu item.
  - ▶ A list of signal tones appears.
4. Select the signal tone that you wish to change using the cursor buttons.
5. Press [OK] to confirm.
6. Select a volume setting using the cursor buttons.
7. Press [OK] to confirm.
8. Press the [ESC] softkey to open the home window.

### 5.11.3 Adjusting the display brightness

The Base remote control unit is fitted with a sensor that automatically adapts the display brightness to the ambient brightness. However, the display brightness can be selected manually if desired.

1. Press any button on the Base unit to display the home window.
2. Press the [input button] to open the menu.
3. Select the *Settings* → *Basic setting* → *Display* → *Brightness* menu item.

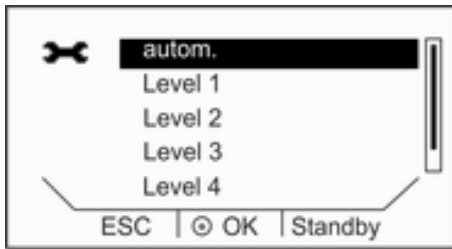

Fig. 35: Adjusting brightness

4. The following options are available in the input window:
  - With the standard setting *Autom.*, the brightness is adapted automatically
  - You can select the brightness manually with entries *Level 1 - 5*. The brightness intensifies from *Level 1*. The display adjusts to the selected degree of brightness immediately.
5. Press the left [cursor button], the [ESC] softkey or [OK] to exit the input window.

#### 5.11.4 Operating mode following a power failure (auto start)

In general, the device is required to resume operation after a power failure. However, you can introduce a manual activation step for safety reasons.

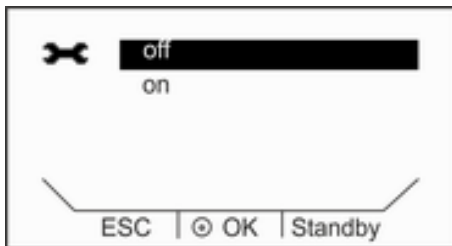

Fig. 36: Selecting auto start setting

1. Press any button on the Base unit to display the Home window.
2. Press the [input button] to open the menu.
3. Select the *Settings* → *Basic setup* → *Auto start* menu item.
4. Select one of the following options:
  - If *Off* is selected, the device is set to standby mode when switched on after a power failure.
  - If *On* is selected and a power failure occurs, the device restarts and continues operating in (*standby/operating*) mode, depending on which was selected prior to the power failure.
5. Press the [Enter key] to confirm.

### 5.11.5 Limiting the current consumption

If your mains fuse is less than 16 A, the current consumption can be reduced incrementally from 16 A to 8 A. The maximum heating power is reduced accordingly. Establish whether other consuming units or only your device is connected to the fused circuit.

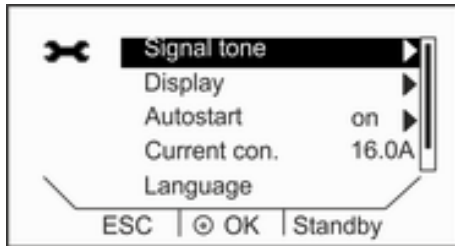

Fig. 37: Current consumption setting

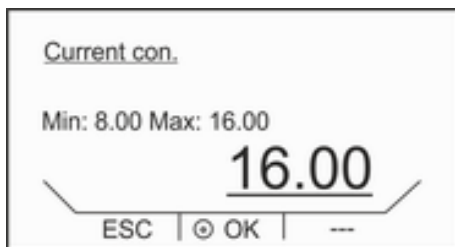

Fig. 38: Specifying current consumption

### 5.11.6 Selecting the menu language



Fig. 39: Selecting the menu language

1. Press any button on the Base unit to display the Home window.
2. Press the [input button] to open the menu.
3. Select the *Settings* → *Basic setting* → *Current consumption* menu item.

4. Change the current consumption accordingly using the cursor buttons.
5. Press the [Enter key] to confirm.

The menu languages available for PRO thermostats with a Base remote control unit are German, English, French, Spanish and Italian.

1. Press any button on the Base unit to display the home window.
2. Press the [input button] to open the menu.
3. Select the *Settings* → *Basic settings* → *Language* menu item.
4. Select one of the available languages.
5. Press the [input button] to confirm.

## 6 Operation

### 6.1 General safety instructions



#### WARNING!

Risk of contact with cold/warm parts if the operator does not realize that the device is switched on.

Scalding, cold burns

- The remote control unit must be kept within visual range of the device.



#### WARNING!

Application-specific dangers due to inadvertently confusing the remote control units for several devices located beside one another

Scalding, cold burns, fire

- Make sure you are using the correct operating unit.



#### CAUTION!

Contact with hot or cold surfaces

Hot and cold burns

- Do not touch the connection nozzle or draining nozzle during operation.
- In addition, the temperature of some bath cover parts may exceed 70 °C at higher operating temperatures.

The following safety notice is relevant for bath thermostats:



#### NOTICE!

Risk of remote control unit falling into the bath

Device damage

- The remote control unit holder must be attached securely to the device.

The following safety notices are relevant for circulation thermostats:



#### DANGER!

Risk of hot heat transfer liquid escaping

Fire

- Degas slowly and carefully. Avoid ignition sources in the vicinity of the filling nozzle and overflow.



**DANGER!**  
Hot heat transfer liquid in the expansion vessel

Fire

- Keep the cover of the expansion vessel closed during operation.



**WARNING!**  
Boiling heat transfer liquid escaping from the filling nozzle

Chemical and heat burns

- Never replenish hot heat transfer liquid with other fluids.

The following safety notices are relevant for devices containing natural refrigerant:



**WARNING!**  
Risk of refrigerant circuit bursting

Escaping combustible refrigerant generates an explosive atmosphere  
Explosion, burns, fire

- Ventilate the room thoroughly without delay.
- During this period, do not operate any switches on the device or anywhere else in the room.
- Do not ignite flames or sparks and refrain from smoking.



**WARNING!**  
Risk of refrigerant circuit bursting from excessive ambient temperatures while device is inoperative

Impacts, cutting, device damage

- Observe the permitted storage and operating temperatures.



**CAUTION!**  
Risk of refrigerant circuit bursting

Hazard to health when inhaled (TLV values exceeded)

- Ventilate the room thoroughly without delay.
- During this period, do not operate any switches on the device or anywhere else in the room.
- Do not ignite flames or sparks and refrain from smoking.

Please also note the following:

- The device may only be moved after it has been drained. For this purpose, the device must be decommissioned.

## 6.2 Operating modes

The device supports two operating modes.

- In *Operation* mode, the components of the device are operational.
- In *Standby* mode, all device component are switched off. Power is only supplied to the display on the device. This operating mode is suitable for adjusting multiple settings, for example.

A program that has been started is paused in *Standby* mode. After activating *Operation* mode, the program must be resumed again manually. ↪ Chapter 6.4 “Activating and deactivating standby and operation modes” on page 79

## 6.3 Setting the pump level

There are several pump levels for regulating the pumps of the bath and circulating thermostats. The different pump levels optimize bath circulation, output, conveyance pressure, noise emissions and mechanical heat input.

↪ Chapter 3.3.1 “Hydraulic circuit” on page 20



*A pump level of 1 to 3 is appropriate for a small bath thermostat without an external consuming unit. A higher output level is appropriate for the circulation thermostat, in order to minimize the temperature difference between the bath and external consuming unit.*

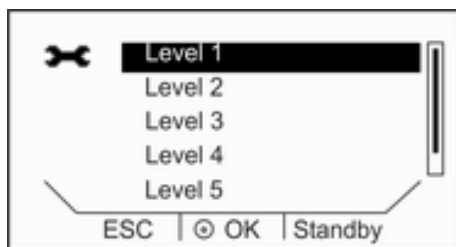

Fig. 40: Setting the pump level

1. Press any button on the Base remote control unit to display the home window.
2. Press the [input button] to open the menu.
3. Select the *Settings* → *Pump level* menu items using the cursor buttons.
  - ▶ The pump levels appear on the display.
4. Select the desired pump level using the cursor buttons.



*The selected pump level is activated automatically. It does not have to be activated separately.*

5. Press the [ESC] softkey to switch to the home window.

## 6.4 Activating and deactivating standby and operation modes

In standby mode, device components such as the pump are switched off. The display remains active, however. Standby mode is ideal for adjusting multiple settings using the operating unit.

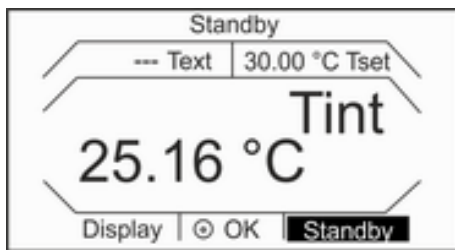

Fig. 41: Standby home window

## 6.5 Defining the actuating signal limit

1. Press any button on the Base unit to display the Home window.
2. Press the [Standby] softkey.
  - ▶ The device is now in standby mode. Standby appears at the top of the display.
3. Press the [Standby] softkey.
  - ▶ The device starts to operate again. The word Standby disappears from the top of the display.

The maximum heating output can be limited using the actuating signal limit. The limit is set as a percentage of the maximum value.

The controller output limit for the heating output is designed to prevent excessive temperatures on the surface of the heater. Excessive heater temperatures may degrade the heat transfer liquid or damage the device.

1. Press any button on the Base unit to display the Home window.
2. Press the [input button] to open the menu.
3. Select the *Settings* → *Control* → *Actuating variable* menu item.
4. Select [Max. heating] and press [OK] to confirm.
  - ▶ An input window appears. The controller output limit can be set to a value within the limit values displayed.
5. Change the value accordingly.
6. Press the [OK] button to return to the previous screen with the new setting configured.
  - ▶ The new setting is active.



*Set the controller output limit before adjusting the control parameters.*

## 6.6 External control

### 6.6.1 Activating external control, deactivating internal control

If you want the device to regulate to another control variable, you must set a new control variable. The old control variable is then deactivated automatically.

Connect a Pt100 temperature probe for monitoring the temperature in the external consumer to the **10S interface** on the constant temperature equipment. The standard indicator for the external measured temperature  $T_{\text{ext}}$  is always the preset external control variable. If the remote control displays a different temperature, this must be set explicitly.



If the external control is activated, the constant temperature equipment regulates the temperature to the external temperature value  $T_{\text{ext}}$  and not to the bath temperature  $T_{\text{int}}$  (bath thermostat) or the outflow temperature  $T_{\text{int}}$  (circulation thermostat).

## Activating the external control

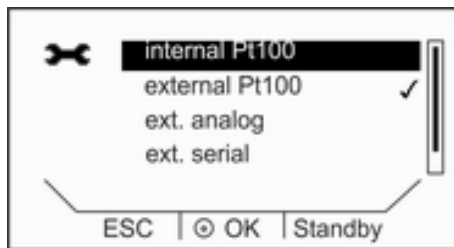

Fig. 42: Activating the external control

1. Connect an external Pt100 temperature probe to the 10S interface on the constant temperature equipment.
2. Insert the Pt100 temperature probe into the heat transfer liquid in the external consuming unit and secure carefully.
3. Press any button on the Base unit to display the Home window.
4. Press the [input button] to open the menu.
5. Select the *Settings* → *Control* → *Controlled variable* menu items using the cursor buttons.
  - ▶ The options appear on the display.
6. Select the option [External Pt100] using the cursor buttons.
  - ▶ The new setting is marked with a check mark.
7. Press the [ESC] softkey to switch to the home window.

## Activating the internal control



Select the option [Internal] in the [Control variable] submenu to activate the internal control again.

## 6.6.2 Setting the set point offset

It is possible to apply an offset value to the temperature measured by an external temperature probe and then process this temperature as a target value. The set point for the bath temperature can therefore be set, for example, to 15 K below the temperature of a reactor measured by the external temperature probe.

### Navigating to the settings

1. Press any button on the Base unit to display the home window.
2. Press the [input button] to open the menu.
3. Select the *Settings* → *Control* → *Setpoint offset* menu items using the cursor button and input button.
4. Select one of the following options:
  - [Offset source] allows you to select the source used to measure the offset.
  - [Diff. set/actual value] allows you to enter the value for the set point offset.

### Entering the offset value

1. Select the [Diff. set/actual] button in the Set point offset menu.
  - ▶ An input window appears. An offset value can be entered within the limit values displayed.

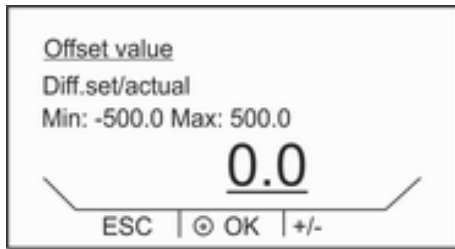

Fig. 43: Entering the offset value

### Activating an offset source

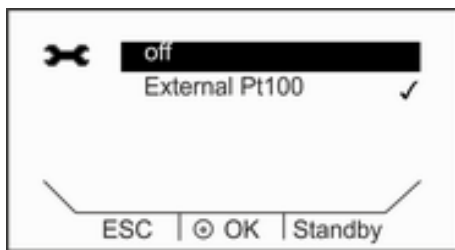

Fig. 44: Offset source menu

2. Enter the set point offset.
3. Press the [input button] to confirm.
4. The software returns to the previous Set point offset menu.

You can activate or deactivate the value entered for the set point offset of a corresponding source using the options in the [Offset source] menu. [External Pt100], for example, allows you to activate the set point offset for the external temperature probe.

1. Select the [Offset source] button in the Set point offset menu.
2. Select one of the following options:
  - Select [Off] to deactivate the offset source.
  - Activate an offset source from the remaining options:
    - [External Pt100]
    - [External analog]
    - [External serial]
    - [External USB]
    - [External Ethernet]
3. Press the [input button] to confirm.
4. Press the [ESC] softkey to open the home window.

## 6.7 Programmer

### 6.7.1 Basic information

The programmer allows you to save a temperature-time program. A program consists of several temperature-time segments. A segment contains specifications relating to program replays, temperature, duration, pump level, control variable and behavior of the switching outputs. Ramps, temperature jumps and temperature maintenance phases are possible.

1. Press any button on the Base unit to display the Home window.
2. Press the [input button] to open the menu.
3. Select the *Programmer* menu item using the cursor buttons.
  - Ramp  
A ramp is defined by the specified duration between the start and the end of the segment, and by the destination temperature, i.e. the temperature at the end of the segment.
  - Temperature jump  
If a time is not specified (time is 0), the end temperature is reached as quickly as possible.
  - Temperature maintenance phase  
No temperature change (i.e. the temperatures at the start and the end of a segment have remained identical).



A maximum of 50 freely programmable segments can be used per program.

## Available settings

	Tend	hh	mm	Tol.
1	23.00	--	--	0.0
2	20.00	0	:0	0.1
3	30.00	0	:10	0.0

ESC | New | Delete

Fig. 45: Editing a program

Setting	Description
---	Program segment number
Tend	End temperature that should be reached
hh	Time in hours (hh) by which the specified temperature should be reached
mm	Time in minutes (mm) by which the specified temperature should be reached
Tol.	Tolerance defines how close the temperature should be to the set temperature before the next segment is processed.  0.00 means that there is no tolerance. In other words, the program focuses on the next temperature when the specified time elapses.
Pmp	Pump level that should be used when processing the segment.
S1, S2, S3	Switching contacts on the contact module (if available) can be programmed here. Contact modules are available as an accessory.

## Editing program examples

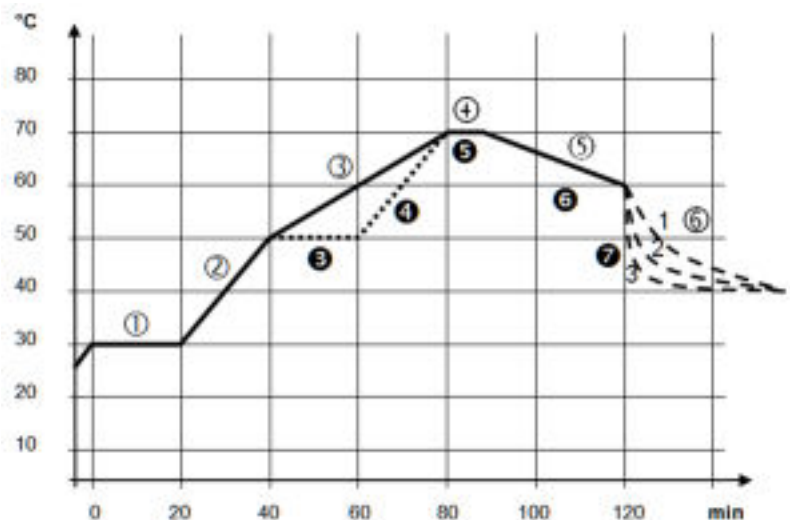

Fig. 46: Program example

The graph shows an example of a reprogrammed set temperature profile.

The cooling time in the graph varies depending on the device type, consumer and so on. In example segment number 2, 50 °C should be reached within 20 minutes.

The original values in the first table below (before) are represented by a solid line, while the values in the edited profile in the second table (after) are represented by a dashed line.

### Segment 1: Start

Each program starts with segment 1, which determines the temperature at which segment 2 continues the program. The temperature of segment 1 is reached as quickly as possible. It is not possible to specify a time limit for segment 1. On thermostats without cooling, the selected start temperature must be higher than the current bath temperature at the time the program starts. Without the segment 1 segment, segment 2 would be different depending on the bath temperature at program start.

Table 35: Program example, before (—)

Before (—)								
	Tend	hh	mm	Tol.	Pmp	S1	S2	S3
1	30.0 0	--	--	0.1	2	off	off	off
2	50.0 0	0	20	0.0	2	off	off	off
3	70.0 0	0	40	0.0	3	off	off	off
4	70.0 0	0	10	0.1	4	off	off	off
5	60.0 0	0	30	0.0	2	off	off	off
6	30.0 0	0	0	0.0	2	off	off	off

In the edited table, a new segment with the number 3 has been entered. The time and the pump level for segment 4 have also been modified. The tolerance and pump level for segment number 5 have been adapted.

Table 36: Program example, after (- - - dashed line, edited)

After (- - -, edited)								
	Tend	hh	mm	Tol.	Pmp	S1	S2	S3
1	30.0 0	--	--	0.1	2	off	off	off
2	50.0 0	0	20	0.0	2	off	off	off
3	50.0 0	0	20	0.1	3	off	off	off
4	70.0 0	0	20	0.0	4	off	off	off
5	70.0 0	0	10	0.8	2	off	off	off

After (---, edited)								
6	60.0 0	0	30	0.0	2	off	off	off
7	30.0 0	0	0	0.0	2	off	off	off

## Tolerance

Note the following and see Fig. 47:

- The Tolerance field ensures strict compliance with the residence time at a specific temperature, for example.
- The subsequent segment is only processed when the actual temperature reaches the tolerance range (1) so the ramp in the second segment is delayed and only starts at 2, for example.
- Selecting a tolerance range that is too small can cause undesired delays. In extreme cases, it may not be possible to continue the program. The selected tolerance range should not be too small, **especially if the control is external**. A greater tolerance has been entered for segment 5 to guarantee adherence to the required time of 10 minutes, even with transient responses (3).
- A tolerance range should only be programmed for flat (slow) ramps, if appropriate. Steep ramps that come close to the maximum possible heating-up or cooling rates of the device may be severely delayed (4) if the tolerance range is too small (in segment 2 here).

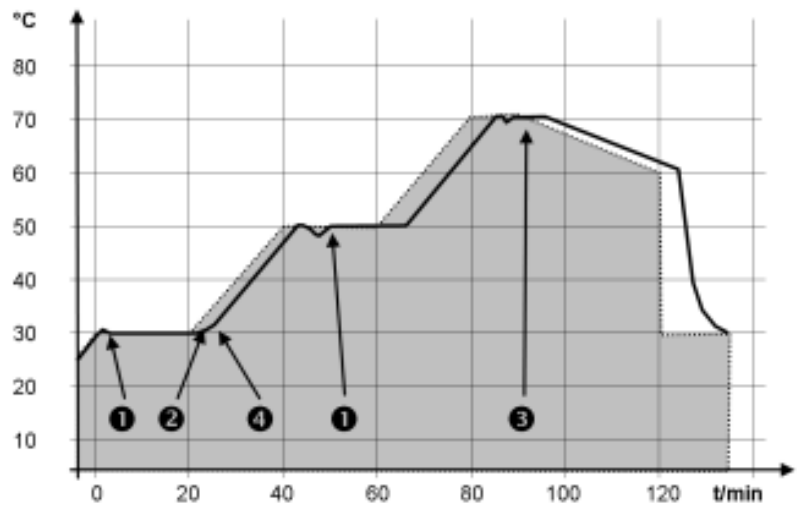

Fig. 47: Target/actual program process

The above graph of the edited process illustrates the possible delay in the development of the actual temperature in the bath vessel (solid line) in relation to the set temperature of the program encoder (gray area).

### 6.7.2 Starting, interrupting, continuing and ending a program

1. Press any button on the Base unit to display the Home window.
2. Press the [input button] to open the menu.

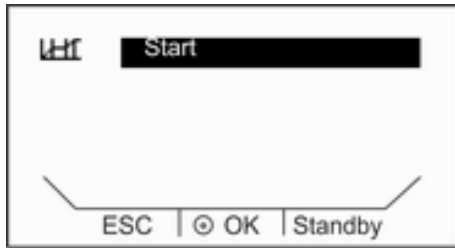

Fig. 48: Defining the program status

3. Select the *Program encoder* → *Edit* menu items using the cursor buttons.

- ▶ The program appears on the display and you can now edit it.

1. Select the [Status] menu item in the Program encoder menu.

2. The following options are available:

- Select the option [Start] to start the program.
- Once the program has started, you can press [Hold] to pause it.
- A paused program can be continued by pressing [Continue].
- Select the option [Stop] to end the program.
- You can pause the program encoder by pressing the [Standby] softkey. Once standby mode is deactivated, the program encoder continues to operate in the previously selected mode (pause or active operation).

## 6.8 Control parameters

Various control parameters for operation of the different PRO thermostat product types have been set ex works. These control parameters are optimized and installed with water as a heat transfer liquid for internal and external control.

- It may be necessary to adapt the configuration on a case by case basis, depending on the application.
- The heating capacity and viscosity of the different heat transfer liquids influence the control behavior.



*Only modify the control parameters if you possess adequate knowledge of control system engineering.*

## 6.8.1 Control basics

### Definition

A brief explanation of terms

Actuating signal	- Initial value of the controller to compensate for the difference between the actual value and target value (control deviation).
PID controller	- The PID controller operates with extreme speed and precision and consists of a P, I and D-component.
Proportional range $X_p$	- The proportional range $X_p$ indicates the temperature range within which the proportional component (P-component) of the controller represents 0 – 100 % of the maximum actuating signal. If the preset $X_p$ is 10 K and the control deviation is 2 K, for example, the P-component is 20 % of the actuating signal. If the control deviation is 10 K or more, the P-component is 100 % of the actuating signal.
Adjustment time $T_n$	- The adjustment time is crucial for the I-component of the actuating signal. It specifies the interval at which an existing control deviation is integrated. The higher the $T_n$ , the slower the control deviation is integrated and the more sluggish the control becomes. A small $T_n$ makes the control more dynamic and eventually results in vibrations.
Hold-back time $T_v$	- The D-component of the actuating signal is formed from the hold-back time $T_v$ . It influences the speed with which the actual value approaches the target value and counteracts the P-component and I-component. The greater the preset hold-back time $T_v$ , the more intensively the output signal is attenuated. Rule of thumb: $T_v = T_n \times 0.75$ .
Attenuation time $T_d$	- Attenuation time of the D-component. Rule of thumb: $T_d = T_v \times 0.15$ .
Correction limitation	- Represents the maximum permitted deviation between the temperature at the external consuming unit and the temperature at the outlet.

### Optimizing the hydraulic system

One important prerequisite for an acceptable control quality is a well designed hydraulic system. The best possible connection must therefore be established between the temperature control application and the constant temperature equipment.

- Use short hoses with a large cross section to reduce the flow resistance. More heat transfer liquid can circulate in a short time, resulting in a shorter circulation time.
- Select the thinnest possible heat transfer liquid with the highest possible heating capacity. Precedence list: Water, water-glycol, oils, Fluorinert®.
- Select the highest possible pump level.
- For external applications, set the flow rate through the external consuming unit as high as possible.
- With bath thermostats, make sure that the circulation in the bath is adequate.

### Effects of viscosity on the heat transfer liquid

A control that is stable at low temperatures will usually be stable at high temperatures. Conversely, if a system is just about stable at high temperatures, it will most probably be unstable at lower temperatures, i.e. vibrate.

The viscosity of the heat transfer liquid changes drastically with the temperature. At low temperatures, liquids are more viscous. The control quality is therefore generally poorer at low temperatures. For this reason, the control setting should be towards the lower end of the temperature range.

If the temperature range of an application is  $-20$  to  $80$  °C, for example, a control setting of  $-10$  to  $20$  °C is most suitable.

### Influence of control parameters on the control behavior

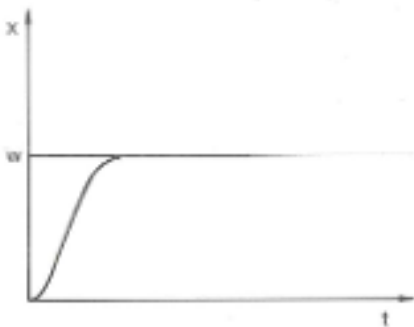
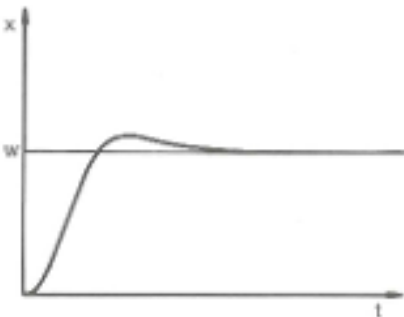
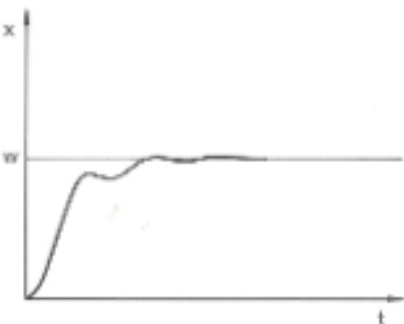

Fig. 49: Ideal setting



If the  $X_p$  parameter selected is too large, the actual value will reach the proportional range early and the P-component will be less than 100 % of the actuating signal. It takes longer to reach the target value and as a result, the simultaneously integrated I-component has more time to establish its actuating signal component. Once the target value is reached, the excessive addition of the I-component causes the value to overshoot the target value. If proportional range  $X_p$  is reduced, the P-component remains at 100 % for longer. Consequently, the actual value approaches the target value more quickly and the I-component has less time to integrate the system deviation. The overshoot is reduced.

Fig. 50: Control parameter  $X_p$  too large



If the proportional range selected is too small, the P-component of the actuating signal remains at 100 % for a long time. This value decreases even faster within the proportional range, i.e. the actuating signal decreases rapidly and the progress of the actual value towards the target value comes almost to a complete stop. The I-component, which only becomes effective now, causes the actual value to move slowly towards the target value.

Fig. 51: Control parameter  $X_p$  too small



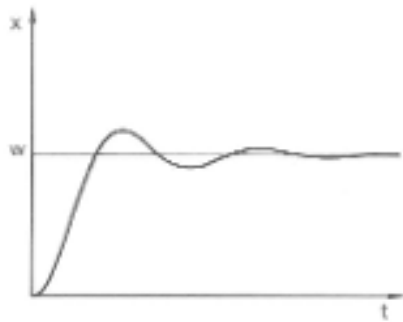

Fig. 52: Control parameters  $T_n$  and  $T_v$  too small

In the case shown here, the preset I-component is too large (parameter  $T_n$  too small,  $T_n$  must be increased). The I-component integrates the control deviation until it becomes 0. If integration proceeds too rapidly, the actuating signal, i.e. the output signal of the controller, is too large. As a result, the actual value fluctuates (fading) around the target value. The hold-back time (parameter  $T_v$ ) should be adapted using the formula:  $T_v = T_n \times 0.75$ .



Fig. 53: Control parameters  $T_n$  and  $T_v$  too large

The actual value increases relatively sharply towards the specified target value. The proportional area settings seem to be correct. If the control deviation becomes smaller, the actual value approaches the target value much more slowly. The integration component (I-component) must compensate for the drastic reduction of the proportional component (P-component). In this case, the I-component is integrated too slowly. The parameter  $T_n$ , which specifies the integration interval, must therefore be reduced. The hold-back time (parameter  $T_v$ ) should be adapted using the formula:  $T_v = T_n \times 0.75$ .

## 6.8.2 Overview of internal control parameters

The internal control compares the set temperature  $T_{set}$  with the bath temperature  $T_{int}$  and calculates the actuating signal, i.e. the measurement used for heating or cooling.

Designation	Abbreviation	Unit
Proportional range	$X_p$	K
Adjustment time	$T_n$	s
Hold-back time	$T_v$	s
Attenuation time	$T_d$	s



If  $T_v$  manual/auto is set to auto,  $T_v$  and  $T_d$  cannot be modified. In this case, they are derived with fixed factors of  $T_n$ .

The following parameters may also influence the internal control:

- Temperature limits:  $T_{il}$  and  $T_{ih}$  ↪ Chapter 5.9 “Setting temperature limits  $T_{ih}$  and  $T_{il}$ ” on page 69
- Controller output limit: Heating power and cooling capacity ↪ Chapter 6.5 “Defining the actuating signal limit” on page 80

### 6.8.3 Overview of external control parameters

The control system for the external actual value is designed as a 2-stage cascade controller to improve guidance behavior and consists of a guide controller (external controller) and a slave controller (internal controller). The temperature of the relevant consuming unit  $T_{ext}$  is also required. This temperature is measured using an external Pt100 temperature probe or an interface for importing the actual temperature.

The guide controller compares the set temperature  $T_{set}$  with the external temperature in the consuming unit  $T_{ext}$  and uses these temperatures to calculate the set temperature (set\_internal) for the slave controller (internal controller).

The slave controller compares the set temperature (set\_internal) with the outlet temperature and calculates the actuating signal, i.e. the measurement used for heating or cooling.

#### Correction limitation

If set temperature  $T_{set}$  indicates a temperature jump, the control may set an outlet temperature much higher than the temperature  $T_{ext}$  required in the external container. Therefore, there is a correction limitation that specifies the maximum permitted deviation between the temperature at the output  $T_{int}$  and the temperature in the external consuming unit  $T_{ext}$ .

#### Control parameters on the guide controller

The following control parameters can be set on the guide controller (PID<sub>1</sub> controller or external controller).

Designation	Abbreviation	Unit
Amplification factor	K <sub>pe</sub>	-
Proportional range	Prop_E	K
Adjustment time	T <sub>ne</sub>	s
Hold-back time	T <sub>ve</sub>	s
Attenuation time	T <sub>de</sub>	s

#### Control parameters on the slave controller

The following control parameters can be set on the slave controller (P-controller).

Designation	Abbreviation	Unit
Proportional range	X <sub>pf</sub>	K



*If Tv manual/auto is set to auto, T<sub>ve</sub>, T<sub>de</sub> and Prop\_E cannot be modified. In this case, they are derived with fixed factors of T<sub>ne</sub>. Prop\_E is a constant predefined value here.*

The following parameters may also influence the external control:

- Temperature limits: T<sub>il</sub> and T<sub>ih</sub> ↪ Chapter 5.9 “Setting temperature limits T<sub>ih</sub> and T<sub>il</sub>” on page 69
- Controller output limit: Heating power and cooling capacity ↪ Chapter 6.5 “Defining the actuating signal limit” on page 80
- Correction limitation ↪ “Correction limitation” on page 90

## 6.8.4 Opening the control menu

1. Press any button on the Base unit to display the home window.
2. Press the [input button] to open the menu.
3. Select the *Settings* → *Control* menu items using the cursor button and [OK].

## 6.8.5 Editing internal control parameters



If you require the controller output limit, set it before adjusting the control parameters. ↪ Chapter 6.5 “Defining the actuating signal limit” on page 80

The internal control in the device is active. Refer to ↪ Chapter 6.6.1 “Activating external control, deactivating internal control” on page 80 for information on reconfiguring the control.

### Adjusting control parameters manually or automatically

The [Tv man/auto] menu item allows you to define whether the control parameters [Tv] and [Td] are adapted manually or configured automatically. If the automatic setting is enabled, both control parameters are marked with the letter "a" and a lock symbol and cannot be selected. In this case, [Tv] and [Td] are derived with fixed factors of [T<sub>n</sub>].

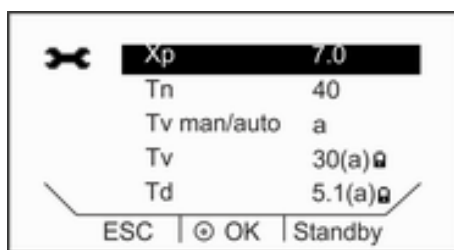

Fig. 54: Tv man/auto

1. Select the *Control parameters* → *Internal* menu item in the Control menu.
2. Select the *Tv man/auto* menu item in the menu.
3. Press the [input button] to confirm the selection.
  - ▶ The manual or automatic setting for the Tv and Td control parameters is immediately active.

## Editing control parameters

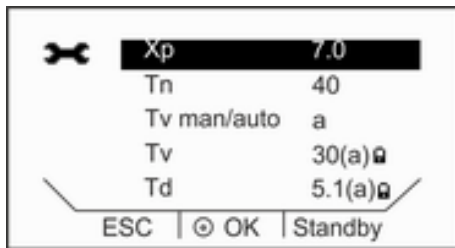

Fig. 55: Internal control parameter menu



Fig. 56: Adapting control parameters Xp

1. Select the *Control parameters* → *Internal* menu item in the Control menu.
2. Select a control parameter.

3. Press the [input button] to confirm the selection.
  - ▶ An input window appears. A value can be entered within the limit values displayed.
4. Change the value accordingly.
5. Press the [input button] to confirm.

### 6.8.6 Editing external control parameters

If you require the controller output limit, set it before adjusting the control parameters. ↪ Chapter 6.5 “Defining the actuating signal limit” on page 80

The external control in the device is active. Refer to ↪ Chapter 6.6.1 “Activating external control, deactivating internal control” on page 80 for information on reconfiguring the control.

### Adjusting control parameters manually or automatically

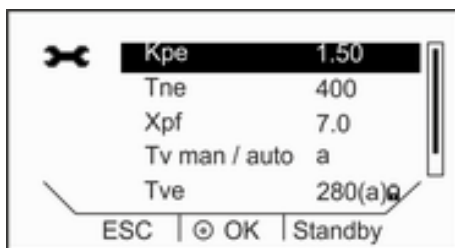

Fig. 57: Tv man/auto

The [Tv man/auto] menu item allows you to define whether the control parameters [Tve], [Tde] and [Prop\_E] are adapted manually or configured automatically. If the automatic setting is enabled, all three control parameters are marked with the letter "a" and a lock symbol and cannot be selected. In this case, [Tve] and [Tde] are derived with fixed factors of [Tne].

1. Select the *Control parameters* → *External* menu item in the Control menu.
2. Select the *Tv man/auto* menu item in the menu.
3. Press the [input button] to confirm the selection.
  - ▶ The manual or automatic setting for the Tve, Tde and Prop\_E control parameters is immediately active.

## Editing control parameters

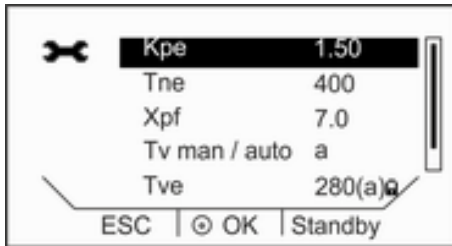

Fig. 58: External control parameter menu



Fig. 59: Adapting control parameters Kpe

1. Select the *Control parameters* → *External* menu item in the Control menu.
2. Select a control parameter.

3. Press the [input button] to confirm the selection.
  - ▶ An input window appears. A value can be entered within the limit values displayed.
4. Change the value accordingly.
5. Press the [input button] to confirm.

## 6.9 Calibrating the temperature probe



A calibrated reference thermometer with the desired level of accuracy is necessary. Otherwise you should not change the calibration of your constant temperature equipment.

If, when checking the temperature in a steady state, you discover a constant temperature deviation of  $T_{int}$  or  $T_{ext}$  from the reference thermometer, this can be equalled out via the *Calibration* menu point.

With the menu point *Offset* (1-point comparison), the characteristic of the temperature switch is adjusted in parallel by the input value.

With the menu point *2-point calibration* (2-point comparison), the characteristic of the temperature switch is adjusted and the slope of the characteristic is changed.



It is possible to change the temperature values  $T_{int}$  and  $T_{ext}$  within a range of  $\pm 3$  K respectively.

### Offset

- For internal bath applications, the reference thermometer must be hung into the bath according to the specifications on the calibration certificate.
  - For external applications, the reference thermometer must be installed in the outflow of the device according to the specifications on the calibration certificate.
  - To measure the temperature, wait until the system is in a steady state.
1. Press any button in the Home window of the Base unit to display the menu bar.
  2. Press the [input button] to open the menu.

3. Using the cursor key and enter key, select the menu points *Settings* → *Calibration* → *internal Pt1000* or → *external Pt100* → *Offset*.
  - ▶ An input window opens.
4. Enter the temperature value read off the reference thermometer into the Base unit.
5. Press enter to confirm the new value.
  - ▶ The new value has been accepted.

## 2-point calibration

- For internal bath applications, the reference thermometer must be hung into the bath according to the specifications on the calibration certificate.
  - For external applications, the reference thermometer must be installed in the outflow of the device according to the specifications on the calibration certificate.
  - The upper and lower temperature value must be at least 40 K apart.
  - To measure the temperature, wait until the system is in a steady state.
1. Set a low  $T_{\text{set}}$  set point on the device.
  2. Wait until the set point and the temperature of the heat transfer liquid have equaled out.
  3. Press any button in the Home window of the Base unit to display the menu bar.
  4. Press the [input button] to open the menu.
  5. Using the cursor key and enter key, select the menu points *Settings* → *Calibration* → *internal Pt1000* or → *external Pt100* → *2-point upper*.
    - ▶ An input window opens.
  6. Enter the temperature value read off the reference thermometer into the Base unit.
  7. Press enter to confirm the new value.
    - ▶ The lower value has been accepted.
  8. Set a high  $T_{\text{set}}$  set point on the device.
  9. Wait until the set point and the temperature of the heat transfer liquid have equaled out.
  10. Select the menu point [2-point upper] in the *Calibration* menu.
  11. Enter the temperature value read off the reference thermometer into the Base unit.
  12. Press enter to confirm the new value.
    - ▶ The upper value has been accepted. 2-point calibration has been completed.

## Restore factory calibration

Use this menu item to restore the calibration configured in the factory.

1. Press any button in the Home window of the Base unit to display the menu bar.
2. Press the [input button] to open the menu.

3. Using the cursor key and enter key, select the menu points *Settings* → *Calibration* → *internal Pt1000* or → *external Pt100* → *Factory Calibration*.
4. Select the option [yes].
5. Press [OK] to confirm the selection.
  - ▶ This deletes the customer's calibration and restores the calibration as it was configured in the factory.

## 6.10 Viewing the device status

1. Press any button on the Base unit to display the home window.
2. Press the [input button] to open the menu.
3. Select the *Settings* → *Device status* menu items using the cursor buttons.
  - ▶ The device status menu appears.
4. The following options are available:
  - Read out error memory
  - View device data
  - View software version
  - View device type
  - View serial number

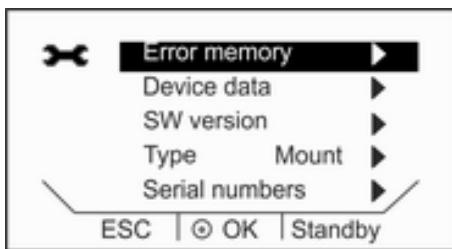

Fig. 60: Device status

### Reading out error memory

Each device has an error memory for storing up to 140 warning, error and alarm messages that can be used to analyze errors.

1. Select the menu item *Device status* → *Errorstore*.



*The most recent message appears in the first position. The message text is displayed in the footer.*

2. You can navigate through the list using the up and down arrow buttons.

The following information is displayed for each message:

- The relevant module that triggered the message is displayed under *Source*.
- *Code* is the encoded description of the alarm, warning or error.
- *Type* specifies whether it is an alarm, warning or error.

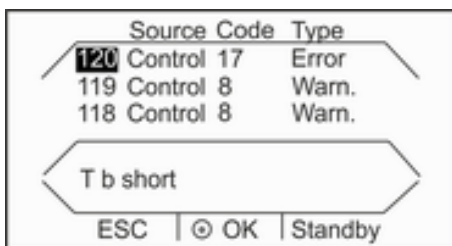

Fig. 61: Error memory

### Displaying the product line and device type

The product line and device type are displayed directly on the menu item in the device status menu. It is not possible to modify settings here.

### Viewing device data

LAUDA Service uses this display for diagnostic purposes. It is not possible to modify settings here.

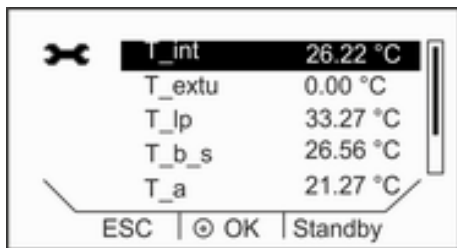

Fig. 62: Device data

1. Select the *Device data* menu item in the Device status menu.
  - ▶ Various device parameters are displayed.

#### Displaying the software version

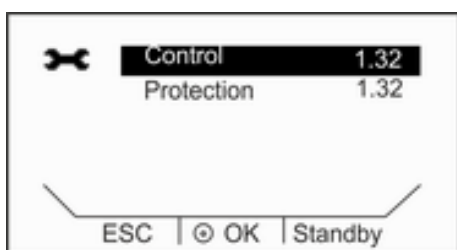

Fig. 63: Display of software versions

The relevant versions of the installed software are required for on-site service visits and telephone support.

1. Select the [SW version] menu item in the Device status menu.
  - ▶ The software versions installed on the device are displayed. The software versions of any connected solenoid valves are also displayed.

#### Displaying the serial numbers

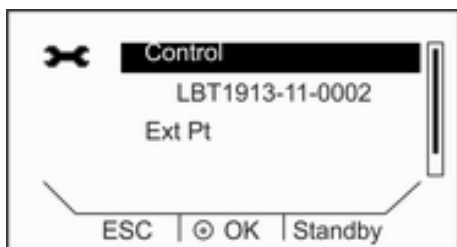

Fig. 64: Serial numbers

The serial numbers are required for on-site service visits and telephone support.

1. Select the [Serial numbers] menu item in the Device status menu.
  - ▶ The serial numbers of the control system, cooling system and Base remote control unit are displayed.



## 7 Maintenance

### 7.1 General safety instructions



**DANGER!**  
Contact with live or moving parts

Electric shock, impacts, cutting, crushing

- The device must be disconnected from the mains power supply before any kind of maintenance is performed.
- Only skilled personnel are permitted to perform repairs.



**WARNING!**  
Malfunctions on the overtemperature protection or low-level protection are not detected

Burns, scalding, fire

- Check the Tmax function and low-level protection on a regular basis.



**CAUTION!**  
Contact with hot or cold device parts, accessories and heat transfer liquid

Scalding, hot or cold burns

- Allow device parts, accessories and heat transfer liquid to reach room temperature before touching.

The following safety notices are relevant for devices containing natural refrigerant:



**WARNING!**  
Risk of mechanical damage to refrigerant circuit

Explosion, fire

- Only trained personnel permitted to perform service work.
- Ventilate the room thoroughly without delay.
- During this period, do not operate any switches on the device or anywhere else in the room.
- Do not ignite flames or sparks and refrain from smoking.



**WARNING!**  
Risk of refrigerant escaping from refrigerant circuit

Explosion, fire

- Before decommissioning the device or if there is a risk of freezing, drain the refrigerant circuit on the refrigerating machine using compressed air or an industrial vacuum cleaner (watertight). Blow compressed air through the circuit.

## 7.2 Maintenance intervals

The maintenance intervals described in the following table must be observed. The following compulsory maintenance tasks must be performed before operating the device for prolonged periods.

Interval	Maintenance work
Weekly	Perform an external visual inspection of the drainage system for leaks
Monthly	Inspect the external condition of the device
	Inspect the external hoses for material fatigue
	Clean the air-cooled condenser
	Clean the dirt trap
	Check the overtemperature protection
Quarterly	Check the low-level protection
	Descale the refrigerating machine and the cooling coil (a shorter interval must be selected, depending on the water hardness and operating period)
Six monthly	Check the heat transfer liquid

## 7.3 Cleaning the device



**WARNING!**  
Risk of cleaning agent entering the device

Electric shock

- Only use a slightly damp cloth to clean the device.

Please also note the following:

- Only use water and detergent to clean the operating unit. Do not use acetone or solvent as these substances will permanently damage the plastic surfaces.
- Ensure that the device is decontaminated after coming into contact with hazardous materials.

- It is forbidden to use decontaminants or cleaning agents that may react with parts of the device or materials contained in those parts and potentially pose a **hazard**.
- We recommend using ethanol as a decontaminant. If you are unsure whether decontaminants or cleaning agents are compatible with parts of the device or the materials contained in those parts, please contact the LAUDA Service department.

## 7.4 Cleaning the air-cooled condenser

This section is relevant for:

- Air-cooled cooling thermostats



**WARNING!**  
Risk of mechanical damage to refrigerant circuit

Explosion, fire

- Do not use pointed objects to clean the condenser.



**CAUTION!**  
Contact with sharp slats on the condenser

Cutting

- Clean the condenser using suitable resources such as a hand brush or compressed air.

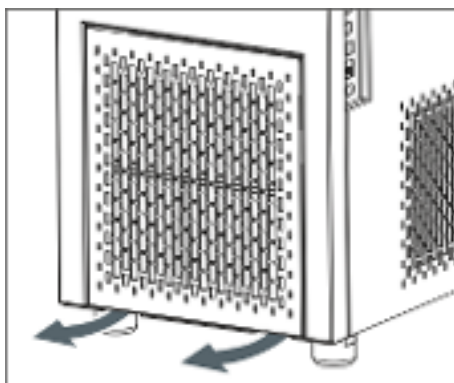

Fig. 65: Removing/attaching the front panel

1. Switch off the device.
  2.
    - Cooling circulation thermostat  
To remove the front panel from the circulating thermostat, grasp the bottom of the panel with both hands and pull it towards you. Remove the front panel slowly and carefully to avoid damage.
    - Cooling bath thermostat  
To remove the front panel from the bath thermostat, grasp the top of the panel with both hands and pull it towards you. Remove the front panel slowly and carefully to avoid damage.
- i** The front panel is retained in position by four magnetic catches.
3. Sweep the slats on the condenser clean using a hand brush. Alternatively, use a vacuum cleaner to clean the slats.
  4. Install the front panel again with care.

## 7.5 Cleaning the water-cooled condenser

The cooling water circuit and dirt trap must be cleaned regularly to maintain maximum cooling output.

## Cleaning the dirt trap



Fig. 66: Counter nuts on the cooling water nozzles

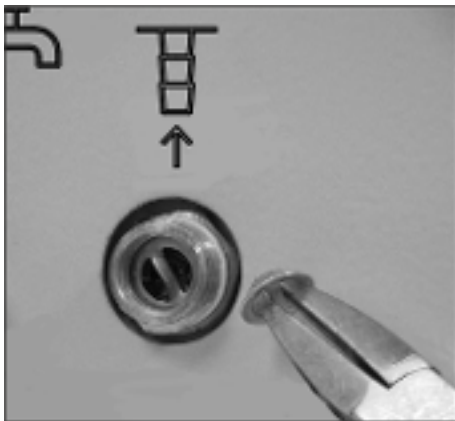

Fig. 67: Dirt trap installed, with pliers

## Descaling the cooling water circuit

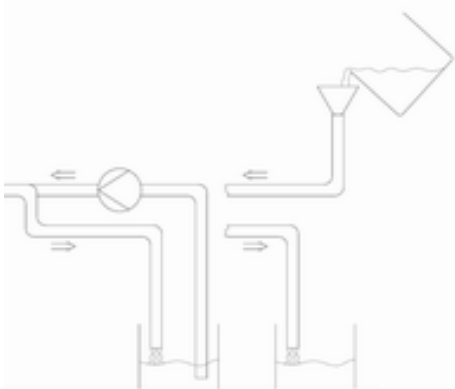

Fig. 68: Descaling

1. Switch off the device at the mains switch.
2. Detach the cooling water hose from the cooling water supply intake.  
Leave the hose on the cooling water outlet (OUT) attached securely to the device.
3. Allow compressed air to flow through the cooling water hose towards the device. Wait until all the water has flowed out of the device before detaching the compressed air supply.
4. Loosen the counter nut on the water cooling intake (IN) of the device by hand. Unscrew the counter nut from the nozzle.



*If the nut is stiff, counter the hexagon bolt with pliers.*

5. Detach the supply hose from the device.
6. Unscrew the dirt trap from the intake nozzle.



*Use flat nose pliers to do this.*

7. Clean the dirt trap and then screw back into the thread on the intake nozzle.
8. Screw the hose back onto the intake nozzle with the counter nut.
9. Screw the counter nut hand-tight.

1. Switch off the device at the mains switch and prepare for the descaling process accordingly.



*Add descaler to the water cooling circuit via the intake using a pump or funnel. The descaler flows back out through the water cooling return hose and into a container with a sufficient volume (approx. 15 liters).*



*LAUDA descaler is required for the descaling process (catalog number LZB 126, 5 kg per pack). Read the safety information and instructions on the packaging before using the chemicals.*

2. Detach the cooling water hose from the cooling water supply intake.
3. Detach the cooling water hose from the cooling water supply outlet.
4. Place the loose end of the return hose into the container.
5. Fill the water cooling supply hose with LAUDA descaler (pump or funnel).

6. Continuously top up or recirculate the descaler. Continue this process until the foaming reaction had subsided. This usually takes 20 to 30 minutes.
7. Then drain the condenser using compressed air.



Refer to ↪ “Draining the water-cooled condenser” on page 101 for detailed information on draining the condenser.

8. Rinse the device thoroughly with fresh water.



Make sure a minimum of 10 liters of water flows through the system.

9. You can now connect the device back to the cooling water supply.

## Draining the water-cooled condenser

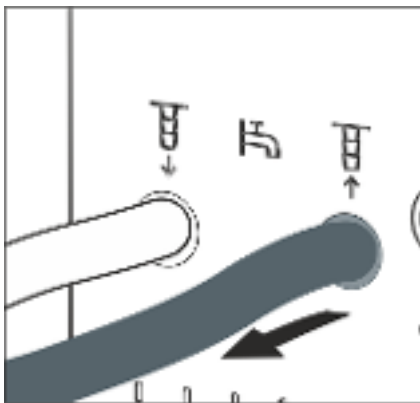

Fig. 69: Cooling water connection socket

1. Switch off the device at the mains switch.
2. Detach the cooling water hose from the cooling water supply intake. Leave the hose on the cooling water outlet (OUT) attached securely to the device.
3. Allow compressed air to flow through the cooling water hose towards the device. Wait until all the water has flowed out of the device before detaching the compressed air supply.

## 7.6 Checking the heat transfer liquid

Contaminated or degenerated heat transfer liquid must be replaced. Continued use of the heat transfer liquid is only permitted following successful testing. The heat transfer liquid must be tested as outlined in DIN 51529.



**CAUTION!**  
Contact with hot/cold heat transfer liquid

Scalding, cold burns

- Bring the heat transfer liquid to room temperature for analysis.

## 7.7 Checking the overtemperature protection

The device must be switched off if the bath temperature exceeds the maximum temperature [T<sub>max</sub>]. The electronics system switches off the device components.

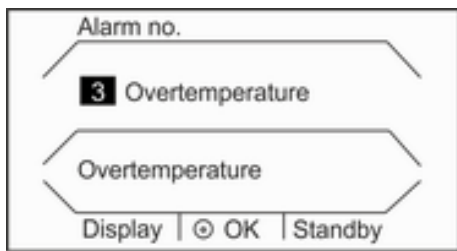

Fig. 70: Overtemperature alarm

1. Switch on the device.
2. Press any button on the Base unit to display the Home window.
3. Slowly lower the maximum temperature [Tmax] using the rotary knob until it is a few °C greater than the bath temperature Tint.
  - ▶ The new preset maximum temperature Tmax appears on the display.
 

The maximum temperature is adopted automatically, the Tmax window is replaced by the home window after a few seconds.
4. Now adjust the set temperature [Tset] higher than the maximum temperature Tmax. Press [OK] to confirm the set temperature.
  - ▶ The device heats up beyond the maximum temperature. The device switches off when the maximum temperature is exceeded. The visual operation and fault indicator (LED) flashes red. Standby appears at the top of the display.
5. Set the correct maximum temperature again using the rotary knob.
  - ▶ The new preset maximum temperature Tmax appears on the display.
 

The maximum temperature is adopted automatically, the Tmax window is replaced by the home window after a few seconds.
6. Press the [red button] to unlock. This button is located on the back or side of the device, depending on the device.
  - ▶ The red light goes out. The signal tone is switched off. The device starts to operate again.

## 7.8 Checking the low-level protection

A double alarm signal sounds before the liquid level decreases so much that the heater is no longer covered completely with liquid. *Low level* appears on the display. The electronics system switches off the device components.



**WARNING!**  
Contact with hot or cold heat transfer liquid

Scalding, cold burns

- Bring the heat transfer liquid to room temperature before draining.



An alarm must sound as soon as the minimum level is reached.

Levels 9 to 0 are displayed.

1. Turn on the device and the pump. Set the bath temperature to room temperature.
2. Reduce the bath level by draining heat transfer liquid from the draining nozzle.
  - ▶ The display shows the drop of the heat transfer liquid.
 

If the liquid falls below level 1, the device switches off and the message *Alarm* appears on the display. The visual operation and fault indicator (LED) flashes red.
3. Top up the heat transfer liquid.
  - ▶ The liquid level rises on the display.
4. Press the [red button] to unlock. This button is located on the back or side of the device, depending on the device.
  - ▶ The red LED goes out. The signal tone is turned off.

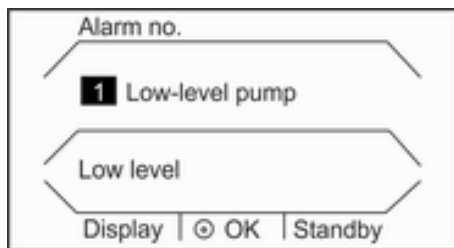

Fig. 71: Low level alarm

## 8 Faults

### 8.1 Alarms, warnings and errors

All alarms, error messages and warnings triggered on the device appear in text form on the display.

#### Procedure in event of alarm

Alarms affect safety. The heater is switched off and the visual operation and fault indicator (LED) flashes red. The device emits a two-tone acoustic signal. Once the cause of the fault has been eliminated, the alarm can be lifted by pressing the red unlock button. This button is located on the back or side of the device, depending on the device.

Refer to [↗](#) Chapter 8.2 “Alarms” on page 104 for a list of alarms.

#### Procedure in event of warning

Warnings do not have a significant effect on safety. The device continues to operate. The device momentarily emits a warning tone. Warnings are issued periodically. Once the cause of the fault has been eliminated, you can acknowledge the warnings on the Base or Command Touch remote control unit.

Refer to [↗](#) Chapter 8.3 “Control system warnings” on page 105 and [↗](#) Chapter 8.4 “Safety system warnings” on page 106 for a list of warnings.

#### Procedure in event of error

If an error occurs, the device emits a two-tone acoustic signal.

If this happens, switch off the device at the mains switch. If the error occurs again after the device is switched back on, note down the error message together with the detailed code. Then contact **LAUDA Service Temperature control devices**. You will find the contact information here [↗](#) Chapter 13.4 “Contact LAUDA” on page 124.



*The error messages appear on the device display together with a detailed code and a consecutive number in the sequence in which they occurred.*

### 8.2 Alarms

Message	Description
Low level	Pump detects a low level (pump speed too high)
Low level	Float detects low level
Overtemperature	Overtemperature ( $T > T_{max}$ )
Pump blocked	Pump blocked (pump stopped)
Base/Command comm.	Base remote control missing or withdrawn during operation.

Code	Message	Description
AI 1	T ext Pt100	External actual value, Pt100 is not available.
AI 2	T ext analog	External actual value, analog signal is not available.



Code	Message	Description
AI 3	Text serial	External actual value of serial interface is not available.
AI 4	Input Analog 1	Analog module: Current input 1, interruption.
AI 5	Input Analog 2	Analog module: Current input 2, interruption.
AI 7	Digital Input	Fault on the digital input/switching contact
AI 12	Text Ethernet	No actual value message via the Ethernet module
AI 14	Communication interrupted	Communication interrupted on the interface module

### 8.3 Control system warnings



All warnings start with the prefix 0. Two numbers will follow the prefix. These numbers can be found in the following table.

Code	English Edition	Description
01	CAN OVERFLOW	Overflow at CAN reception
02	WATCHDOG RESET	Watchdog reset
03	TIL LIMIT	til limit active
04	TIH LIMIT	tih limit active
05	HS OVERHEAT	Heater has overheated
06	FREE 5	
07	FREE 6	
08	INVALID PARAMETER	Invalid parameter in the memory
09	UNKNOWN NODE	Unknown CAN node module connected
10	OLD SWV R	Control system software version is too old
11	OLD SWV S	Protection system software version is too old
12	OLD SWV B	Operating system software version is too old
13	OLD SWV T	Temperature control system software version is too old
14	OLD SWV A	Analog module software version is too old
15	OLD SWV RS232	RS232 module software version is too old
16	OLD SWV D	Digital module software version is too old
17	OLD SWV M0	Solenoid valve (cooling water valve) software version is too old
18	OLD SWV M1	Solenoid valve (automatic filling device) software version is too old
19	OLD SWV M2	Solenoid valve (constant level device) software version is too old

Code	English Edition	Description
20	OLD SWV M3	Solenoid valve (shut-off valve 1) software version is too old
21	OLD SWV M4	Solenoid valve (shut-off valve 2) software version is too old
22	OLD SWV M5	High-temperature cooler software version is too old
23	OLD SWV P0	Pump 0 software version is too old
24	OLD SWV P1	Pump 1 software version is too old
25	OLD SWV P2	Pump 2 software version is too old
26	OLD SWV P3	Pump 3 software version is too old
27	OLD SWV S0	External Pt module software version is too old
28	OLD SWV EN	Ethernet module software version is too old
29	OLD SWV EC	EtherCAT module software version is too old
30	OLD SWV U	Universal module software version is too old
31	OLD SWV B1	Operating system 1 (command or base) software version is too old
32	SWV RESERVED	Reserved for software version XXX is too old
33	CALIBRATION	Faulty calibration of a temperature probe
34	STACK ADC OVERFLOW	TaskADC: Stack overflow
35	STACK CHECK OVERFLOW	TaskCheck: Stack overflow
36	STACK USB OVERFLOW	TaskUSB: Stack overflow
37	STACK EN OVERFLOW	TaskEthernet: Stack overflow
38	STACK CAN OVERFLOW	TaskCan: Stack overflow
39	STACK CONTROL OVERFLOW	TaskControl: Stack overflow
56	FREI56	

#### 8.4 Safety system warnings



All warnings start with the prefix 1. Two numbers will follow the prefix. These numbers can be found in the following table.

Code	English Edition	Description
01	CAN OVERFLOW	Overflow at CAN reception
02	WATCHDOG RESET	Watchdog reset
03	SAFE MODE	SAFE MODE signal as a warning
04	NO RESPONSE RTT	No response to relay/Triac test request
05	BATH LOLEVEL FLOAT	Low level of float (currently level 2)

Code	English Edition	Description
06	FREE 5	
07	FREE 6	
08	INVALID PARA NV	Invalid parameter in the memory
09	UNKNOWN NODE	Unknown CAN node module connected
10	OLD SWV R	Control system software version is too old
11	OLD SWV S	Protection system software version is too old
12	OLD SWV B	Operating system software version is too old
13	OLD SWV T	Temperature control system software version is too old
14	OLD SWV A	Analog module software version is too old
15	OLD SWV RS232	RS232 module software version is too old
16	OLD SWV D	Digital module software version is too old
17	OLD SWV M0	Solenoid valve (cooling water valve) software version is too old
18	OLD SWV M1	Solenoid valve (automatic filling device) software version is too old
19	OLD SWV M2	Solenoid valve (constant level device) software version is too old
20	OLD SWV M3	Solenoid valve (shut-off valve 1) software version is too old
21	OLD SWV M4	Solenoid valve (shut-off valve 2) software version is too old
22	OLD SWV M5	High-temperature cooler software version is too old
23	OLD SWV P0	Pump 0 software version is too old
24	OLD SWV P1	Pump 1 software version is too old
25	OLD SWV P2	Pump 2 software version is too old
26	OLD SWV P3	Pump 3 software version is too old
27	OLD SWV S0	External Pt module software version is too old
28	OLD SWV EN	Ethernet module software version is too old
29	OLD SWV EC	EtherCAT module software version is too old
30	OLD SWV U	Universal module software version is too old
31	OLD SWV B1	Operating system 1 (command or base) software version is too old
32	SWV RESERVED	Reserved for software version XXX is too old
33	CAN WARNING	CAN communication issue has occurred
34	CALIBRATION	Faulty calibration of a temperature probe
56	FREI56	

## 8.5 SmartCool warnings



All warnings start with the prefix 3. Two numbers will follow the prefix. These numbers can be found in the following table.

Code	English Edition	Description
01	CAN receive overf	Overflow at CAN reception
02	Watchdog reset	Watchdog reset
03	Missing SM adaption1	Perform adaptation cycle
04	Pressure switch 1 activated	Pressure switch KM1 in cooling circuit triggered
05	CONDENSER DIRTY	Condenser dirty → clean
06	KLIXON1	KM1: to1 is too high, Klixon has most probably triggered
07	Invalid Parameter	Impermissible parameter in the memory
08	CAN system	Internal data exchange issue
09	Unknown module	Unknown module connected
10	SWV CONTROL OLD	Operating system software version is too old
11	SWV SAFETY OLD	Protection system software version is too old
13	SWV COOL OLD	Temperature control system software version is too old
14	SWV ANALOG OLD	Analog module software version is too old
15	SWV SERIAL OLD	Serial module software version is too old
16	SWV CONTACT OLD	Contact module software version is too old
17	SWV VALVE 0 OLD	Valve module 0 software version is too old
18	SWV VALVE 1 OLD	Valve module 1 software version is too old
19	SWV VALVE 2 OLD	Valve module 2 software version is too old
20	SWV VALVE 3 OLD	Valve module 3 software version is too old
21	SWV VALVE 4 OLD	Valve module 4 software version is too old
22	SWV PUMP 0 OLD	Pump module 0 software version is too old
23	SWV PUMP 1 OLD	Pump module 1 software version is too old
24	SWV PUMP 2 OLD	Pump module 2 software version is too old
25	SWV PUMP 3 OLD	Pump module 3 software version is too old
26	SWV HTC OLD	High-temperature cooler software version is too old
27	SWV EXT PT OLD	External Pt module software version is too old
28	SWV ETHERNET OLD	Ethernet module software version is too old
29	SWV ETHERCAT OLD	EtherCAT module software version is too old
30	SWV UNIVERSAL	Universal module software version is too old

Code	English Edition	Description
31	SWV COMMAND 1 OLD	Operating system 1 (command or base) software version is too old
32	SWV RESERVED	Reserved for software version XXX is too old
33	MISSING ADAPT2	
34	PRESS SWITCH2	Pressure switch KM2 has triggered
35	KLIXON2	KM2: to1 is too high, Klixon has most probably triggered
36	SMIN TOO SMALL	to1 is too low in minimum position
37	VALVE NOT CLOSED	Cooling valve does not close correctly during adaptation cycle
38	CALIBRATION	Faulty calibration of a temperature probe
39	VALVE CHANGED	A valve was modified/replaced
40	WRONG NET FREQUENCY	
41	WRONG NET VOLTAGE	
42	NO PRO TYPE	Invalid PRO device type
43	NO PRO VOLTAGE	Invalid PRO mains voltage setting
44	KM CURRENT NOT OK	Refrigerating machine frequency incorrect
45	STACK OVERFLOW CAN	TaskCan: 90 % stack utilization exceeded
46	STACK OVERFLOW ADC	TaskADC: 90 % stack utilization exceeded
47	STACK OVERFLOW CHECK	TaskCheck: 90 % stack utilization exceeded
48	STACK OVERFLOW COOL	TaskCool: 90 % stack utilization exceeded
49	STACK OVERFLOW FAN	TaskFan: 90 % stack utilization exceeded
50	RTOS MISC	
51	KM OFF AT SERV	Refrigerating machine switched off during adaptation/flushing
52	Free 52	
53	Free 53	
54	Free 54	
55	Free 55	
56	Free 56	

## 9 Decommissioning

### 9.1 General information on decommissioning

Information on decommissioning and course of action if there is a risk of freezing

- Drain the internal cooling water coil on the heating bath thermostat and heating circulation thermostat (both directions suitable) using compressed air or a watertight industrial vacuum cleaner.
- If the device has a refrigerating machine, drain the cooling water circuit on the refrigerating machine (both directions suitable) using compressed air or a watertight industrial vacuum cleaner.
- Drain the pump chamber on the circulation thermostat from the intake side using compressed air or a watertight industrial vacuum cleaner.

 <b>NOTICE!</b> Risk of refrigerant escaping from refrigerant circuit	
	Device damage
	<ul style="list-style-type: none"><li>● Before decommissioning the device or if there is a risk of freezing, drain the refrigerant circuit on the refrigerating machine using compressed air or an industrial vacuum cleaner (watertight). Blow compressed air through the circuit.</li></ul>

 <b>NOTICE!</b> Pump output decreases	
	Device damage
	<ul style="list-style-type: none"><li>● Before decommissioning the device or if there is a risk of freezing, drain the pump completely from the intake side. Blow compressed air through the circuit.</li></ul>

The following safety notices are relevant for devices containing natural refrigerant:

 <b>WARNING!</b> Risk of refrigerant escaping from refrigerant circuit	
	Explosion, fire
	<ul style="list-style-type: none"><li>● Before decommissioning the device or if there is a risk of freezing, drain the refrigerant circuit on the refrigerating machine using compressed air or an industrial vacuum cleaner (watertight). Blow compressed air through the circuit.</li></ul>



Refer to Chapter 9.2 “Changing/draining heat transfer liquid” on page 111 for detailed information on draining the heat transfer liquid.

## 9.2 Changing/draining heat transfer liquid



**WARNING!**  
Contact with hot or cold heat transfer liquid

Scalding, cold burns

- Bring the heat transfer liquid to room temperature before draining.



**WARNING!**  
Splashing heat transfer liquid

Eye damage

- Always wear suitable safety glasses when working on the device.



Fig. 72: Attaching hose



Observe the regulations for the disposal of used heat transfer liquid.

1. Allow the device and heat transfer liquid to cool or warm up to room temperature.
2. Turn off the device and pull out the mains plug.
3. Attach a hose to the drain nozzle.
4. Place the hose in a suitable container to collect the heat transfer liquid.



*It may be necessary to drain the device several times if the filling volume is high.*

5. Open the drain tap by turning it counterclockwise.



*Drain the bath, external consuming unit, accessories and hoses completely.*

6. If necessary, clean or flush out the device (with new heat transfer liquid, for example).



*After changing to a different heat transfer liquid, you may have to set new values for the temperature limit, overtemperature switch-off point and/or the controller output limit.*

## 10 Disposal

### 10.1 Disposing of refrigerant

Disposal of refrigerant must proceed according to regulation 2015/2067/EU in combination with regulation 517/2014/EU.

<b>!</b> NOTICE! Uncontrolled escape of refrigerant	
	Environment
	<ul style="list-style-type: none"><li>● Never dispose of a cooling circuit that is still pressurized.</li><li>● Only specialized personnel are permitted to perform disposal work.</li></ul>

The following safety notice is relevant for devices containing natural refrigerant:

<b>!</b> CAUTION! Uncontrolled escape of refrigerant	
	Explosion, fire
	<ul style="list-style-type: none"><li>● Never dispose of a cooling circuit that is still pressurized.</li><li>● Only specialized personnel are permitted to perform disposal work.</li></ul>

<b>i</b>	<i>The refrigerant type and filling weight are printed on the type plate.</i>
----------	---

### 10.2 Device disposal



The following applies for EU member states: The device must be disposed of according to Directive 2012/19/EU (WEEE Waste of Electrical and Electronic Equipment).

### 10.3 Disposing of packaging

The following applies for EU member states: Disposal of the packaging must proceed according to regulation 94/62/EC.



## 11 Technical data

The information has been conveyed in accordance with DIN 12876.

### 11.1 General data

Table 37: Base remote control unit

Specification	Value	Unit
Display type	OLED monochrome graphic display	---
Display size	2.7	Inches
	61 x 30	mm
Display resolution	128 x 64	Pixels
Display resolution	0.01	°C
Setting resolution	0.01	°C

Table 38: Shared device data

Specification	Value	Unit
Installation and use	Indoors	---
Maximum height of installation above sea level	up to 2,000	m
Humidity	Maximum relative air humidity 80 % at ambient temperature of 31 °C and up to 40 °C, 50 % with linear decrease	---
Ambient temperature range	5 – 40	°C
IP protection level	IP 21	---
Mains voltage fluctuations	Up to ±10 % of the nominal voltage	
Protection class for electrical equipment DIN EN 61 140 (VDE 0140-1)	1	---
Class division according to DIN 12 876-1	III	---
		FL (suitable for combustible and non-combustible liquids)
Bath thermostat temperature stability*	±0.01	K
Circulation thermostat temperature stability*	±0.05	K
Storage temperature range	5 – 40	°C
Transportation temperature range	-20 – 50	°C
	-20 – 43	°C
	-20 – 50	°C
	-20 – 43	°C

\* Measured value according to standard DIN 12876-2 (12/2001)



The noise level of the various devices was measured according to the guidelines included in DIN EN ISO 11200 and the basic standards cited therein. The measured values correspond to the operating conditions that occur during typical device operation.

Table 39: Heating bath thermostats

	Unit	P 10	P 20	P 30
Working temperature range	°C	40 – 250	35 – 250	30 – 250
Operating temperature range (with external cooling)	°C	-30 – 250	-30 – 250	-30 – 250
Device dimensions (W x D)	mm	310 x 335	350 x 475	400 x 600
Device height (H), including base	mm	365	365	365
Bath opening (W x D)	mm	240 x 150	300 x 290	340 x 385
Bath depth (H)	mm	200	200	200
Usable depth	mm	180	180	180
Filling volume				
- maximum	L	10.0	20.0	28.5
- minimum	L	5.5	11.0	15.5
Connecting thread on cooling coil (thermal devices only)	Inches	Thread G3/8" external & G1/4" internal	Thread G3/8" external & G1/4" internal	Thread G3/8" external & G1/4" internal
Noise level (1 m)	dB(A)	49	49	49
Weight	kg	13	19	23
Clearance				
- Front	mm	200	200	200
- Back	mm	200	200	200
- Right	mm	200	200	200
- Left	mm	200	200	200

Table 40: Cooling bath thermostats

	Unit	RP 2040	RP 3035	RP 2045	RP 1090	RP 2090	RP 10100
*ACC area	°C	-40 – 200	-35 – 200	-45 – 200	-90 – 200	-90 – 200	-100 – 200
Device dimensions (W x D)	mm	400 x 565	440 x 600	400 x 565	440 x 600	500 x 600	500 x 600
Device height (H), including base	mm	680	680	680	730	730	730
Bath opening (W x D)	mm	300 x 290	340 x 375	300 x 290	240 x 150	300 x 290	240 x 150
Bath depth (H)	mm	200	200	200	200	200	200
Usable depth	mm	180	180	180	180	180	180
Filling volume							
- maximum	L	21.0	29.5	21.0	11.0	21.0	11.0
- minimum	L	12.5	17.5	12.5	6.5	12.5	6.5
Noise level (1 m)	dB(A)	52	52	53	54	54	54
Weight	kg	54	57	59	88	89	88
Clearance							
- Front	mm	200	200	200	200	200	200
- Back	mm	200	200	200	200	200	200
- Right	mm	200	200	200	200	200	200
- Left	mm	200	200	200	200	200	200



\*ACC area (Active Cooling Control) according to DIN 12876 is the working temperature range during operation with an active refrigerating machine.

Table 41: Cooling circulation thermostats and heating circulation thermostats

	Unit	RP 240 E	RP 245 E	RP 250 E	RP 290 E	P 2 E
*ACC area/working temperature range	°C	-40 – 200*	-45 – 200*	-50 – 200*	-90 – 200*	80 – 250
Operating temperature range (heating device with external cooling)	°C	---	---	---	---	-30 – 250
Device dimensions (W x D)	mm	300 x 430	300 x 430	300 x 430	390 x 600	250 x 365
Device height (H), including base	mm	675	675	675	685	425
Filling volume						
- maximum	L	4.4	4.4	4.4	4.4	4.4
- minimum	L	2.4	2.4	2.4	2.4	2.4
Pump data						
Maximum discharge pressure	bar	0.7	0.7	0.7	0.7	0.7
Maximum pump suction	bar	0.4	0.4	0.4	0.4	0.4
Maximum flow rate pressure	l/min	22	22	22	22	22
Maximum flow rate suction	l/min	20	20	20	20	20
Pump connecting thread	mm	M16 x 1	M16 x 1	M16 x 1	M16 x 1	M16 x 1
Connecting thread on cooling coil (thermal devices only)	Inches	---	---	---	---	Thread G3/8" external & G1/4" internal
Noise level (1 m)	dB(A)	54	54	57	56	47
Weight	kg	46	46	47	79	16
Clearance						
- Front	mm	200	200	200	200	200
- Back	mm	200	200	200	200	200
- Right	mm	200	200	200	200	200
- Left	mm	200	200	200	200	200



\*ACC area (Active Cooling Control) according to DIN 12876 is the working temperature range during operation with an active refrigerating machine.

## 11.2 Cooling capacity and cooling water



The devices are operated with partially halogenated and/or natural refrigerant, depending on the device model. The cooling output values measured for partially halogenated refrigerant and natural refrigerant are identical. The designation and refrigerant charge are specified on the device type plate.



The cooling output is measured when the heat transfer liquid reaches a certain temperature. These temperature values are specified in brackets. The ambient temperature for the measurement is 20 °C and ethanol was used as a heat transfer liquid. To measure water-cooled devices, the cooling water temperature is 15 °C and the cooling water differential pressure is 3 bar.



The cooling water must be a minimum of 5 – 10 K cooler than the ambient temperature of the device to ensure efficient cooling.

Table 42: Cooling water data

Specification	Value
Maximum cooling water pressure	10 bar
Minimum differential pressure of cooling water (input - output) $\Delta p$	0 bar
Maximum differential pressure of cooling water (input - output) $\Delta p$	3.0 bar
Cooling water temperature	15 °C recommended, 10 to 30 °C permitted (in upper temperature range with reduced cooling output)
Diameter of cooling water hoses	10 mm



#### Cooling water hoses

Hoses with an inner diameter of 10 mm are recommended for the nipples supplied with the device.

Table 43: Single-stage refrigerating machine

	Unit	RP 2040	RP 3035	RP 2045	Pump level
Cooling capacity at 20 °C	W	800	800	1500	8
at 10 °C	W	800	800	1430	8
at 0 °C	W	800	800	1170	8
at -10 °C	W	600	580	840	8
at -20 °C	W	400	350	520	4
at -30 °C	W	190	160	280	4
at -35 °C	W	110	100	200	4
at -40 °C	W	60	---	130	4
at -45 °C	W	---	---	70	4
at -50 °C	W	---	---	---	---

	Unit	RP 2040	RP 3035	RP 2045	Pump level
Cooling water connection sockets	Inches	Thread G3/8" external & G1/4" internal	Thread G3/8" external & G1/4" internal	Thread G3/8" external & G1/4" internal	---
Flow of cooling water with temperature of 15 °C	l/min	1 bar ⇔ 2.1	1 bar ⇔ 2.1	1 bar ⇔ 1.3	---

	Unit	RP 240 E	RP 245 E	RP 250 E	Pump level
Cooling capacity at 20 °C	W	600	800	1500	8
at 10 °C	W	600	800	1440	8
at 0 °C	W	600	800	1200	8
at -10 °C	W	410	530	840	8
at -20 °C	W	240	340	540	4
at -30 °C	W	120	150	290	4
at -35 °C	W	70	90	---	4
at -40 °C	W	20*	40	110	4
at -45 °C	W	---	10*	40	4
at -50 °C	W	---	---	20	2
Cooling water connection sockets	Inches	Thread G3/8" external & G1/4" internal	Thread G3/8" external & G1/4" internal	Thread G3/8" external & G1/4" internal	---
Flow of cooling water with temperature of 15 °C	l/min	1 bar ⇔ 2.1	1 bar ⇔ 2.1	1 bar ⇔ 2.1	---

\* measured with pump level 2

Table 44: Dual-stage refrigerating machine

	Unit	RP1090	RP 2090	RP10100	RP 290 E	Pump level
Cooling capacity at 20 °C	W	800	800	400	800	8
at 10 °C	W	750	710	400	770	8
at 0 °C	W	720	680	400	740	8
at -10 °C	W	690	650	400	720	8
at -20 °C	W	660	620	400	700	4
at -30 °C	W	630	610	390	680	4
at -40 °C	W	600	580	370	640	4
at -50 °C	W	540	520	350	540	4

	Unit	RP 1090	RP 2090	RP 10100	RP 290 E	Pump level
at -60 °C	W	370	340	320	390	4
at -70 °C	W	240	180	250	210	4
at -80 °C	W	110	70	170	90	4
at -90 °C	W	20	10	60	10*	4
at -100 °C	W	---	---	10	---	4
Cooling water connection sockets	Inches	Thread G3/8" external & G1/4" internal	Thread G3/8" external & G1/4" internal	Thread G3/8" external & G1/4" internal	Thread G3/8" external & G1/4" internal	---
Flow of cooling water with temperature of 15 °C	l/min	1 bar ⇔ 2.1	1 bar ⇔ 2.1	1 bar ⇔ 2.1	1 bar ⇔ 2.1	---

\* measured with pump level 2

### 11.3 Refrigerant and filling weight

#### Devices containing semi-halogenated refrigerant

The device contains fluorinated greenhouse gases.

Table 45: Single-stage refrigerating machine

	Unit	RP 2040*	RP 3035*	RP 2045*
Refrigerant	---	R-404A	R-404A	R-404A
Maximum filling weight	kg	0.25	0.25	0.3
GWP <sub>(100a)</sub> *	---	3922	3922	3922
CO <sub>2</sub> equivalent	t	1.0	1.0	1.2

	Unit	RP 240 E	RP 245 E	RP 250 E
Refrigerant	---	R-449A	R-449A	R-452A
Maximum filling weight	kg	0.3	0.3	0.3
GWP <sub>(100a)</sub> *	---	1397	1397	2140
CO <sub>2</sub> equivalent	t	0.4	0.4	0.6

\* Only available outside the EU

**Devices containing semi-halogenated and natural refrigerant**

The device contains fluorinated greenhouse gases.

Table 46: 2-stage refrigerating machine

	Unit	RP 1090	RP 2090	RP 10100	RP 290 E
Refrigerant (1st stage)	---	R-404A	R-404A	R-404A	R-452A
Maximum filling weight (1st stage)	kg	0.26	0.26	0.22	0.3
GWP <sub>(100a)</sub> *	---	3922	3922	3922	2140
CO <sub>2</sub> equivalent	t	1.0	1.0	0.9	0.6
Refrigerant (2nd stage)	---	R-170	R-170	R-1150	R-170
Maximum filling weight (2nd stage)	kg	0.08	0.08	0.06	0.07
GWP <sub>(100a)</sub> *	---	3	3	3	3

**Devices containing natural refrigerant**

Table 47: Single-stage refrigerating machine

	Unit	RP 2040	RP 3035	RP 2045
Natural refrigerant	---	R-290	R-290	R-290
Maximum filling weight	kg	0.099	0.099	0.149
GWP <sub>(100a)</sub> *	---	3	3	3

	Unit	RP 240 E	RP 245 E	RP 250 E
Natural refrigerant	---	R-290	R-290	R-290
Maximum filling weight	kg	0.12	0.12	0.14
GWP <sub>(100a)</sub> *	---	3	3	3

**Devices containing natural refrigerant**

Table 48: 2-stage refrigerating machine

	Unit	RP 1090	RP 2090	RP 10100	RP 290 E
Refrigerant (1st stage)	---	R-290	R-290	R-290	R-290
Maximum filling weight (1st stage)	kg	0.11	0.11	0.099	0.12
GWP <sub>(100a)</sub> *	---	3	3	3	3
Refrigerant (2nd stage)	---	R-170	R-170	R-1150	R-170
Maximum filling weight (2nd stage)	kg	0.08	0.08	0.06	0.07
GWP <sub>(100a)</sub> *	---	3	3	3	3





Global Warming Potential (GWP), CO<sub>2</sub> comparison = 1.0  
 \*Time frame 100 years - according to IPCC IV

## 11.4 Maximum current consumption and heating output



\*The maximum current consumption may be limited in the factory, depending on the mains cable supplied → Chapter 5.11.5 “Limiting the current consumption” on page 76.

Table 49: Heating bath thermostat and heating circulation thermostat

Power supply	Current consumption setting*	Heating output in kW			
		P 10	P 20	P 30	P 2 E
200-230 V; 50/60 Hz	12 A	---	---	---	1.9 – 2.5
200-230 V; 50/60 Hz	13 A	2.6 – 3.0	2.6 – 3.0	2.6 – 3.0	---
200-230 V; 50/60 Hz	15 A	2.7 – 3.4	2.7 – 3.4	2.7 – 3.4	---
200-230 V; 50/60 Hz	16 A	2.7 – 3.6	2.7 – 3.6	2.7 – 3.6	---
100-120 V; 50/60 Hz	16 A	1.3 – 1.9	1.3 – 1.9	1.3 – 1.9	1.3 – 1.8

Table 50: Cooling bath thermostats

Power supply	Current consumption setting*	Heating output in kW					
		RP 2040	RP 2045	RP 3035	RP 1090	RP 2090	RP 10100
230 V; 50 Hz	13 A	3.0	3.0	3.0	3.0	3.0	3.0
230 V; 50 Hz	15 A	3.4	3.4	3.4	3.4	3.4	3.4
230 V; 50 Hz	16 A	3.6	3.6	3.6	3.6	3.6	3.6
208-220 V; 60 Hz	13 A	2.7 – 2.9	2.7 – 2.9	2.7 – 2.9	2.7 – 2.9	2.7 – 2.9	2.7 – 2.9
208-220 V; 60 Hz	16 A	2.9 – 3.3	2.9 – 3.3	2.9 – 3.3	2.9 – 3.3	2.9 – 3.3	2.9 – 3.3
200 V; 50/60 Hz	16 A	2.7	2.7	2.7	2.7	2.7	2.7
120 V; 60 Hz	16 A	1.9	---	1.9	---	---	---
100 V; 50/60 Hz	15 A	1.3	---	1.3	---	---	---
100 V; 50/60 Hz	16 A	1.3	---	1.3	---	---	---

Table 51: Cooling circulation thermostats

Power supply	Current consumption setting*	Heating output in kW			
		RP 240 E	RP 245 E	RP 250 E	RP 290 E
230 V; 50 Hz	13	2.5	2.5	---	---
230 V; 50 Hz	15	2.5	2.5	---	---
230 V; 50 Hz	16	2.5	2.5	2.5	2.5
208-220 V; 60 Hz	13	2.1 – 2.3	2.1 – 2.3	---	---
208-220 V; 60 Hz	16	2.1 – 2.3	2.1 – 2.3	2.0 – 2.3	2.0 – 2.3
200 V; 50/60 Hz	16	1.9	1.9	1.9	1.9
120 V; 60 Hz	16	1.8	1.8	---	---
100 V; 50/60 Hz	15	1.3	1.3	---	---
100 V; 50/60 Hz	16	1.3	1.3	---	---

11.5 Pump characteristics

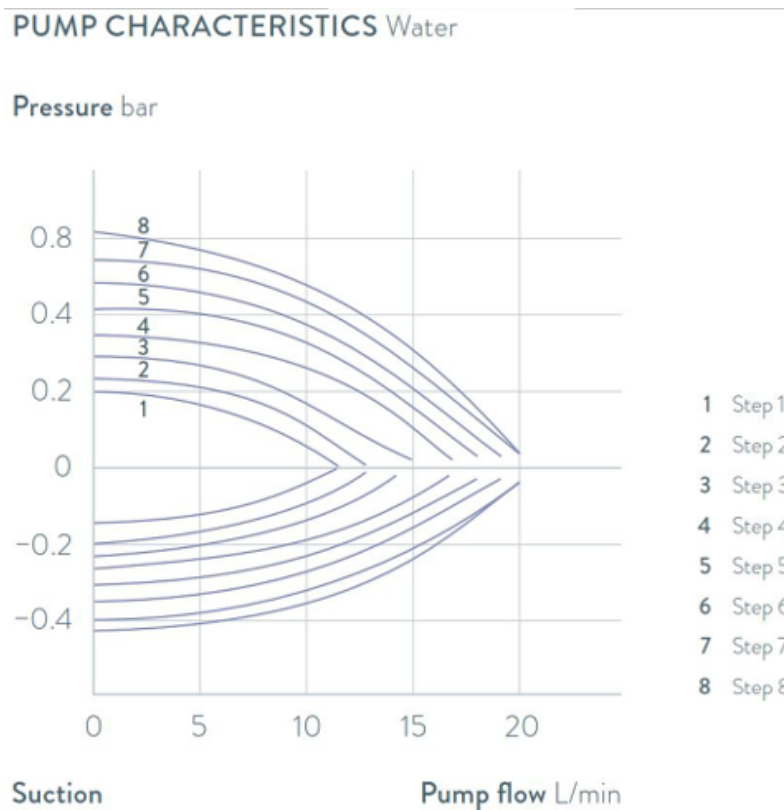

Fig. 73: Pump characteristics of the circulation thermostats

## 12 Accessories

The following optional accessories are available for PRO devices.

Table 52: Module bay 51 mm x 27 mm

Accessory	Cat. No.
Analog interface module	LRZ 912
RS232/485 interface module	LRZ 913
Contact interface module with 1 input and 1 output	LRZ 914
Contact interface module with 3 inputs and 3 outputs	LRZ 915
Profibus interface module	LRZ 917
Ethernet/USB interface module	LRZ 921
EtherCAT interface module, M8 socket connection	LRZ 922
EtherCAT interface module, RJ45 socket connection	LRZ 923

Table 53: Connecting plug

Accessory	Cat. No.
External temperature probe with socket and shielded connection cable	ETP 059
Coupling connector, 6-pin for analog inputs/outputs	EQS 057
Connecting plug SUB-D, 9-pin	EQM 042
RS232 cable (length: 2 m) for PC	EKS 037
RS232 cable (length: 5 m) for PC	EKS 057
3-pin coupling connector for contact input	EQS 048
3-pin coupling socket for contact output	EQD 047

Accessory	Suitable for	Cat. No.
Command Touch remote control unit	All devices	LRT 923

## 13 General

### 13.1 Copyright

This manual is protected by copyright and only meant for internal use by purchasers.

The relinquishment of this manual to third parties, copying in any way whatsoever – even in the form of excerpts – and the utilization and/or conveyance of its content are not allowed, except for internal purposes, without written approval from the manufacturer.

Violation of this may obligate the violator to the payment of damages. Other claims reserved.

We point out that the designations and brand names of the respective companies used in the manual are generally subject to trademark, brand and patent protection.

### 13.2 Technical changes

The manufacturer reserves the right to make technical modifications to the device.

### 13.3 Warranty conditions

LAUDA grants a standard warranty of one year on all devices.

### 13.4 Contact LAUDA

Contact the LAUDA Service department in the following cases:

- Troubleshooting
- Technical questions
- Ordering accessories and spare parts

Please contact our sales department for questions relating to your specific application.

#### Contact information

LAUDA Service

Phone: +49 (0)9343 503-350

Email: [service@lauda.de](mailto:service@lauda.de)

### 13.5 Declaration of Conformity and certificates



## EU DECLARATION OF CONFORMITY

**Manufacturer:** LAUDA DR. R. WOBSEER GMBH & CO. KG  
Laudaplatz 1, 97922 Lauda-Königshofen Germany

We hereby declare under our sole responsibility that the machines described below

**Product Line:** PRO **Serial number:** from S210000001

**Types:** P 10, P 20, P 30, P 2 E, Additional pump PRO

comply with all relevant provisions of the EC Directives listed below due to their design and type of construction in the version brought on the market by us:

Machinery Directive	2006/42/EC
EMC Directive	2014/30/EU
RoHS Directive	2011/65/EU In connection with (EU) 2015/863

The equipment is not covered by the Pressure Equipment Directive 2014/68/EU, as the maximum classification of the equipment is Category 1 and it is covered by the Machinery Directive.

The protective objectives of the Machinery Directive with regard to electrical safety are complied with in accordance with Annex I Paragraph 1.5.1 in conformity with the Low Voltage Directive 2014/35/EU.

Applied harmonized standards:

- EN ISO 12100:2010
- EN 61326-1:2013
- EN 55011:2016 + A1:2017
- EN 61000-6-3:2007/A1:2011/AC:2012
- EN IEC 61000-6-2:2019
- EN 61326-3-1:2018
- EN 61010-1:2010/A1:2019/AC:2019-04
- EN 61010-2-010:2014

Authorized representative for the composition of the technical documentation:

Dr. Jürgen Dirscherl, Head of Research & Development

Lauda-Königshofen, 23.09.2021



Dr. Alexander Dinger, Head of Quality Management



## EU DECLARATION OF CONFORMITY

**Manufacturer:** LAUDA DR. R. WOBSEER GMBH & CO. KG  
Laudaplatz 1, 97922 Lauda-Königshofen, Germany

We hereby declare under our sole responsibility that the machines described below

**Product Line:** PRO **Serial number:** from S210000001

**Types:** RP 3035, RP 2040, RP 2045, RP 1090, RP 2090, RP 10100,  
RP 240 E, RP 245 E, RP 250 E, RP 290 E

comply with all relevant provisions of the EC Directives listed below due to their design and type of construction in the version brought on the market by us:

Machinery Directive	2006/42/EC
Low voltage directive	2014/35/EU
EMC Directive	2014/30/EU
RoHS Directive	2011/65/EU in connection with (EU) 2015/863

The equipment is not covered by the Pressure Equipment Directive 2014/68/EU, as the maximum classification of the equipment is Category 1 and it is covered by the Machinery Directive.

The protective objectives of the Machinery Directive with regard to electrical safety are complied with in accordance with Annex I Paragraph 1.5.1 in conformity with the Low Voltage Directive 2014/35/EU.

Applied harmonized standards:

- EN ISO 12100:2010
- EN 378-2:2016
- EN 61326-1:2013
- EN 55011:2016 + A1:2017
- EN 61000-6-3:2007/A1:2011/AC:2012
- EN IEC 61000-6-2:2019
- EN 61326-3-1:2018
- EN 61010-1:2010/A1:2019/AC:2019-04
- EN 61010-2-010:2014

Authorized representative for the composition of the technical documentation:

Dr. Jürgen Dirscherl, Head of Research & Development

Lauda-Königshofen, 23.09.2021

Dr. Alexander Dinger, Head of Quality Management

\*FAHRENHEIT. °CELSIUS. °LAUDA.

Document number: Q5WA-QA13-003-EN Version 05

## EC DECLARATION OF CONFORMITY

**Manufacturer:** LAUDA DR. R. WOBSE GMBH & CO. KG  
Laudaplatz 1, 97922 Lauda-Königshofen, Germany

We hereby declare under our sole responsibility that the devices described below

**Product Line:** Operating units Base and Command Touch      **Serial number:** from S210000001

**Types:** Base, Order number LRT 922,  
Command Touch, Order number LRT 923

comply with all relevant provisions of the EC Directives listed below due to their design and type of construction in the version brought on the market by us:

EMC Directive      2014/30/EU  
RoHS Directive      2011/65/EU in connection with (EU) 2015/863

Applied standards:

- EN IEC 61326-1:2021
- EN 61326-3-1:2017
- EN 55011:2016 + A1:2017
- EN 61000-6-3:2007/A1:2011/AC:2012
- EN IEC 61000-6-2:2019
- EN 61010-1:2010 + A1:2019 + A1:2019/AC:2019

Authorized representative for the composition of the technical documentation:

Dr. Jürgen Dirscherl, Head of Research & Development

Lauda-Königshofen, 26.06.2023

  
\_\_\_\_\_  
Dr. Alexander Dinger,  
Head of Quality and Environmental Management

The certificate is only valid for devices with cTUVus certification marks on the rating label.





America

## CERTIFICATE

No. U8 019054 0012 Rev. 00

**Holder of Certificate:** LAUDA  
**DR. R. WOBSE** GMBH & CO. KG  
 Pfarrstraße 41/43  
 97922 Lauda-Königshofen  
 GERMANY

**Certification Mark:**



**Product:** Temperature controller  
 Process Temperature Controller PRO

This product was voluntarily tested to the relevant safety requirements referenced on this certificate. It can be marked with the certification mark above. The mark must not be altered in any way. This product certification system operated by TÜV SÜD America Inc. most closely resembles system 3 as defined in ISO/IEC 17067. Certification is based on the TÜV SÜD "Testing and Certification Regulations". TÜV SÜD America Inc. is an OSHA recognized NRTL and a Standards Council of Canada accredited Certification body.

**Test report no.:** 713196257

**Date,** 2021-06-16

( Benedikt Pulver )



America

# CERTIFICATE

No. U8 019054 0012 Rev. 00

**Model(s):** P2E \* NRTL  
 RP240E\* NRTL  
 RP245E\* NRTL  
 RP250E\* NRTL  
 RP290E\* NRTL  
 \* (C – Command Touch)

**Tested according to:** UL 1995:2018  
 CSA C22.2 No. 236:2015

**Parameters:**

**P2E\* NRTL**  
 Rated voltage: 100V - 120V, 1Ph./ N / Gr.  
 Rated frequency: 60 Hz  
 Rated current: 16A  
 Protection class: IP 21

**P2E\* NRTL**  
 Rated voltage: 200V - 230V, 1Ph./ N / Gr.  
 Rated frequency: 60 Hz  
 Rated current: 16A  
 Protection class: IP 21

**RP240E\* NRTL**  
 Rated voltage: 120V, 1 Ph. / 208V - 220V AC /  
 Rated frequency: 60 Hz  
 Rated current: 16A  
 Protection class: IP 21



America

ZERTIFIKAT ◆ CERTIFICATE ◆ 認證書 ◆ CERTIFICADO ◆ CERTIFICAT

## CERTIFICATE

No. U8 019054 0012 Rev. 00

### RP240E\* NRTL

Rated voltage: 208V-220V AC, 1Ph., N , Gr.  
 Rated frequency: 60 Hz  
 Rated current: 16A  
 Protection class: IP 21

### RP245E\* NRTL

Rated voltage: 208V-220V AC, 1Ph., N , Gr.  
 Rated frequency: 60 Hz  
 Rated current: 16A  
 Protection class: IP 21

### RP250E\* NRTL

Rated voltage: 208V-220V AC, 1Ph., N , Gr.  
 Rated frequency: 60 Hz  
 Rated current: 16A  
 Protection class: IP 21

### RP290E\* NRTL

Rated voltage: 208V-220V AC, 1Ph., N , Gr.  
 Rated frequency: 60 Hz  
 Rated current: 16A  
 Protection class: IP 21

\* C (with or without touch remote control)

### 13.6 Product Returns and Clearance Declaration

#### Product Returns

Would you like to return a LAUDA product you have purchased to LAUDA? For the return of goods, e.g. for repair or due to a complaint, you will need the approval of LAUDA in the form of a *Return Material Authorization (RMA)* or *processing number*. You can obtain the RMA number from our customer service department at +49 (0) 9343 503 350 or by email [service@lauda.de](mailto:service@lauda.de).

#### Return address

LAUDA DR. R. WOBSEER GMBH & CO. KG

Laudaplatz 1

97922 Lauda-Königshofen

Deutschland/Germany

Clearly label your shipment with the RMA number. Please also enclose this fully completed declaration.

RMA number	Product serial number
Customer/operator	Contact name
Contact email	Contact telephone
Zip code	Place
Street & house number	
Additional explanations	

#### Clearance Declaration

The customer/operator hereby confirms that the product returned under the above-mentioned RMA number has been carefully emptied and cleaned, that any connections have been sealed to the farthest possible extent, and that there are no explosive, flammable, environmentally hazardous, biohazardous, toxic, radioactive or other hazardous substances in or on the product.

Place, date	Name in block letters	Signature

## 14 Glossary

<b>Auto IP</b>	Auto IP is a standardized procedure where two or more participants agree on the same network configuration.
<b>DHCP Client (Dynamic Host Configuration Protocol Client)</b>	A DHCP client facilitates the automatic integration of an Ethernet interface in an existing network. As a result, the interface does not have to be manually integrated in the existing network.
<b>DNS server (Domain Name Service Server)</b>	The Domain Name Service is a database where mainly information on names and IP addresses of the computer are stored. A DNS can, for example, disperse a web address or URL (Uniform Resource Locator) to an IP address. The Ethernet interface specifies the IP address of the DNS server present in the connected network.
<b>Gateway</b>	Various networks are connected with one another via a gateway. Here, an IP address is given that can be used to reach a gateway in a local network.
<b>IP address (Internet Protocol Address)</b>	Each device within a data network requires an address, so that it can be clearly identified. This is the only way to ensure that e.g. the data flow is received by the correct device. When an Internet page is opened, the browser always transfers the IP address of your device. This is the only way that the web server can know where to send the required data packet. The Internet Protocol (IP) is a widely adopted network standard that stipulates how information can be exchanged.
<b>IP version</b>	Provides information about the Internet standard: IPv4 or IPv6.  A well-known example of an IP address is 192.168.0.1. This address is structured according to the IPv4 standard: Four numbers between 0 and 255, whereby a period separates the numbers from one another. However, this system only allows a limited number of combinations, which is why there are IP addresses structured according to the standard in version 6 (IPv6). They consist of eight blocks of characters that can contain both numbers and letters as shown in this example: fe80:0010:0000:0000:0000:0000:0000:0001. Because this can seem rather confusing, a long string of zeros can be replaced by a colon. The IPv6 address from the example would therefore appear in a shortened form as follows: fe80:0010::1.
<b>Local IP address</b>	The local IP address is an address for the Ethernet interface in the local network. The Ethernet interface in the local network can be reached using this address. If the DHCP client is deactivated, the local IP address and the local mask must be manually configured. For manual configuration start by contacting your IT department.
<b>Local mask</b>	Local (subnet) masks are used to flexibly adapt the rigid class division of IP addresses in networks and computers to actual conditions.
<b>MAC (Media Access Control)</b>	Media Access Control is an almost unique global hardware address which can be used to clearly identify the device in an Ethernet network.
<b>NTP (Network Time Protocol)</b>	Network time protocol is a standard for synchronizing the time and date in networks.
<b>Port</b>	Port is a number that is used to establish a connection between two network participants. The port is a part of the network address. The port for the Ethernet interface can be taken from the approved "dynamic ports" range. This lies between 49152 and 65535.

## Process Interface

A process interface on the LAUDA constant temperature equipment is the interface that makes it possible to control or monitor the constant temperature equipment via Ethernet using LAUDA interface command sets.

## TCP (Transmission Control Protocol)

This network protocol define how data is exchanged between network components.

## 15 Index

### A

Accessories	
In series . . . . .	14
Modules . . . . .	123
Accessory . . . . .	123
Adjusting the brightness (display) . . . . .	74
Adjusting the display brightness . . . . .	74
Adjusting the volume (signal tone) . . . . .	74
Adjustment time . . . . .	87, 89, 90
Air-cooled	
Cleaning the condenser . . . . .	99
Alarm . . . . .	104
Codes . . . . .	104
Alarms . . . . .	104
Amplification factor . . . . .	90
Attenuation time . . . . .	87, 89, 90
Autostart	
Activating . . . . .	75
Deactivating . . . . .	75

### B

Base	
Menu structure . . . . .	68
Bath cover (illustration) . . . . .	16
Bath draining nozzle (illustration) . . . . .	16, 18
Bath thermostat	
Structure . . . . .	16
Button	
Release . . . . .	20

### C

Calibrate (actual temperature)	
Determine . . . . .	93
Calibration in the factory . . . . .	93
Changing	
Signal tones . . . . .	74
Checking	
Heat transfer liquid . . . . .	101
Low-level protection . . . . .	102
Overtemperature protection . . . . .	101

Tmax . . . . .	101
Circulation thermostat	
Connecting an external consuming unit . . . . .	54
Hoses . . . . .	52
Setting up . . . . .	51
Cleaning . . . . .	98
CO2 equivalent . . . . .	119
Code	
Warnings (control system) . . . . .	105
Warnings (safety system) . . . . .	106
Warnings (SmartCool) . . . . .	108
Compressor . . . . .	22
Condenser	
Cleaning (air-cooled) . . . . .	99
Cleaning (water-cooled) . . . . .	100
Connecting an external consuming unit . . . . .	54
Contact . . . . .	124
Control . . . . .	35
Defining the controller output limit . . . . .	80
Warnings . . . . .	105
Control menu . . . . .	91
Control parameters	
Access . . . . .	91
Adapting (external) . . . . .	92
External (overview) . . . . .	90
Internal (overview) . . . . .	89
Modifying (internal) . . . . .	91
Control station . . . . .	35
Cooling coil . . . . .	21
Cooling coil connection socket (illustration) . . . . .	16
Cooling water	
Connecting . . . . .	57
Requirements . . . . .	55
Copyright . . . . .	124
Correction limitation . . . . .	87, 90
Cracking . . . . .	80
Cursor buttons (illustration) . . . . .	65
<b>D</b>	
Defining the language (display) . . . . .	76

Defining the menu language . . . . .	76	External control	
Descaling . . . . .	100	Activation . . . . .	80
Device		Defining the set point offset . . . . .	81
Cleaning . . . . .	98	<b>F</b>	
Cleaning condenser (air-cooled) . . . . .	99	Factory calibration . . . . .	93
Decontamination . . . . .	98	Fault . . . . .	104
Descaling (water-cooled) . . . . .	100	Feet (illustration) . . . . .	18
Displaying serial numbers . . . . .	96	Filling . . . . .	60
Disposal (packaging) . . . . .	112	Filling weight . . . . .	119
Disposal (refrigerant) . . . . .	112	Flushing . . . . .	63, 111
Draining . . . . .	63, 111	Front panel (illustration) . . . . .	18
Draining condenser (water-cooled) . . . . .	101	<b>G</b>	
Filling . . . . .	60	Grip (illustration) . . . . .	18
Installation . . . . .	30	<b>H</b>	
Read out memory . . . . .	95	Heat discharge . . . . .	23
Switching on . . . . .	65	heat transfer liquid	
Unpacking . . . . .	14	Removal . . . . .	63, 111
Viewing data . . . . .	95	Heat transfer liquid	
DIN EN 378-1 . . . . .	10	Checking . . . . .	101
Dirt trap . . . . .	99	Flushing . . . . .	63, 111
Display . . . . .	74	Heating output	
Display buttons		reduction . . . . .	80
Operation . . . . .	65	Hold-back time . . . . .	87, 89, 90
Displaying serial numbers (device) . . . . .	96	Hoses . . . . .	52
Disposal		Hybrid . . . . .	23
Packaging . . . . .	112	HyperTerminal . . . . .	39
Refrigerant . . . . .	112	<b>I</b>	
Disposing of refrigerant . . . . .	112	Immunity . . . . .	7
Draining		Input button (position) . . . . .	65
Condenser (water-cooled) . . . . .	101	Installation (device) . . . . .	30
Device . . . . .	63, 111	Installation location . . . . .	30
<b>E</b>		Intended use . . . . .	9
Emissions class . . . . .	7	Interface	
Error . . . . .	104	Description . . . . .	24
Modules . . . . .	50	Overview . . . . .	24
Read out memory . . . . .	95	Interface module	
Establishing a mains connection . . . . .	64	Installing . . . . .	30
Establishing a power supply . . . . .	64	Internal control	
Evaporator . . . . .	22	Activation . . . . .	81
Expansion . . . . .	22		



<b>K</b>		
Key lock . . . . .	65	
Kpe . . . . .	90	
<b>L</b>		
Limits		
Setting . . . . .	69	
Limits (temperature)		
Setting . . . . .	69	
Low-level protection		
Checking . . . . .	102	
Definition . . . . .	12	
<b>M</b>		
Maintenance		
Intervals . . . . .	98	
Maximum temperature . . . . .	101	
Menu structure		
Base . . . . .	68	
Modules		
Accessories . . . . .	123	
Monitor . . . . .	35	
<b>N</b>		
N2 . . . . .	24	
Nitrogen . . . . .	24	
Connection . . . . .	19	
<b>O</b>		
Offset (actual temperature)		
Calibrate . . . . .	93	
Overtemperature protection		
Checking . . . . .	101	
Definition . . . . .	11	
Setting . . . . .	68	
<b>P</b>		
Packaging		
Disposal . . . . .	112	
Personal protective equipment (overview) . . . . .	11	
Platforms . . . . .	51	
Power failure (operating mode) . . . . .	75	
Program		
Ending . . . . .	85	
Example . . . . .	82	
Interrupting . . . . .	85	
Starting . . . . .	85	
Program optimization		
Description . . . . .	82	
Prop_E . . . . .	90	
Proportional range . . . . .	87, 89, 90	
Protective equipment (personal, overview) . . . . .	11	
Pump		
Selecting the flow rate level . . . . .	79	
Selecting the level . . . . .	79	
Selecting the output level . . . . .	79	
SteadyFlow function . . . . .	21	
Pump nozzle (illustration) . . . . .	18	
<b>R</b>		
Racks . . . . .	51	
Rating label . . . . .	26	
Device (illustration) . . . . .	16, 18	
Reading out memory (error) . . . . .	95	
Refrigerant		
Combustible . . . . .	10	
Filling weight . . . . .	119	
Fluorinated . . . . .	10	
Refrigerating machine		
Function . . . . .	22	
Release . . . . .	20	
Remote control unit (illustration) . . . . .	16	
Rising platforms . . . . .	51	
Risk of freezing . . . . .	110	
RS 485 module		
Connecting . . . . .	33	
<b>S</b>		
Safety notice		
General . . . . .	7	
Safety system (warnings) . . . . .	106	
Segment		
Start . . . . .	83	
Service . . . . .	124	

Setting the current consumption . . . . .	76
Signal tone (adjusting) . . . . .	74
SmartCool (warnings) . . . . .	108
Softkey (illustration) . . . . .	65
Software version . . . . .	96
Standby	
Activating . . . . .	79
Deactivating . . . . .	79
Start	
Segment . . . . .	83
SteadyFlow function . . . . .	21
Stirrer	
Selecting the level . . . . .	79
Switching on . . . . .	65

## T

Td . . . . .	87, 89
Tde . . . . .	90
Temperature target value . . . . .	70
Terminal program . . . . .	39
Tih, Til . . . . .	69
Til, Tih . . . . .	69
Time period . . . . .	42
Tmax	
Checking . . . . .	101
Position . . . . .	20
Setting . . . . .	68
Tn . . . . .	87, 89
Tne . . . . .	90
Tv . . . . .	87, 89
Tve . . . . .	90

## U

Unpacking . . . . .	14
USB . . . . .	25

## V

Ventilation grid (illustration) . . . . .	18
Version (software) . . . . .	96
Viewing configuration data (device) . . . . .	95

## W

Warning . . . . .	104
Control system . . . . .	105
Safety system . . . . .	106
SmartCool . . . . .	108
Warranty . . . . .	124
Water cooling	
Draining . . . . .	110
Water-cooled	
Connection socket (position) . . . . .	18
Draining the condenser . . . . .	101

## X

Xp . . . . .	87, 89
Xpf . . . . .	90



Manufacturer:

LAUDA DR. R. WOBSE GMBH & CO. KG ° Laudaplatz 1 ° 97922 Lauda-Königshofen

Telephone: +49 (0)9343 503-0

E-mail: [info@lauda.de](mailto:info@lauda.de) ° Internet: <https://www.lauda.de>